

# Multi Inverter air conditioner

# Service Manual

## CONTENTS

1. Important Notice
2. Technical Specification
3. Product Dimensions
4. Refrigeration cycle diagram
5. Operation details
6. Wiring diagram
7. Explosion view and parts
8. Precaution
9. Names of parts
10. Installation
11. Trouble shooting

## 1. Important Notice

This service manual is intended for use by individuals possessing adequate backgrounds of electrical, electronic and mechanical experience. Any attempt to repair the appliance may result in personal injury and property damage. The manufacturer or seller cannot be responsible for the interpretation of this information, nor can it assume any liability in connection with its use.

The information, specifications and parameter are subject to change due to technical modification or improvement without any prior notice. The accurate specifications are presented on the nameplate label.

### **How to order spare parts**

To have your order filled promptly and correctly, please furnish the following information:

1. Model No. with Indoor or Outdoor
2. No. in the Explosion View
3. Part Name
4. The quantity you ordered

## 2. Refrigeration cycle diagram

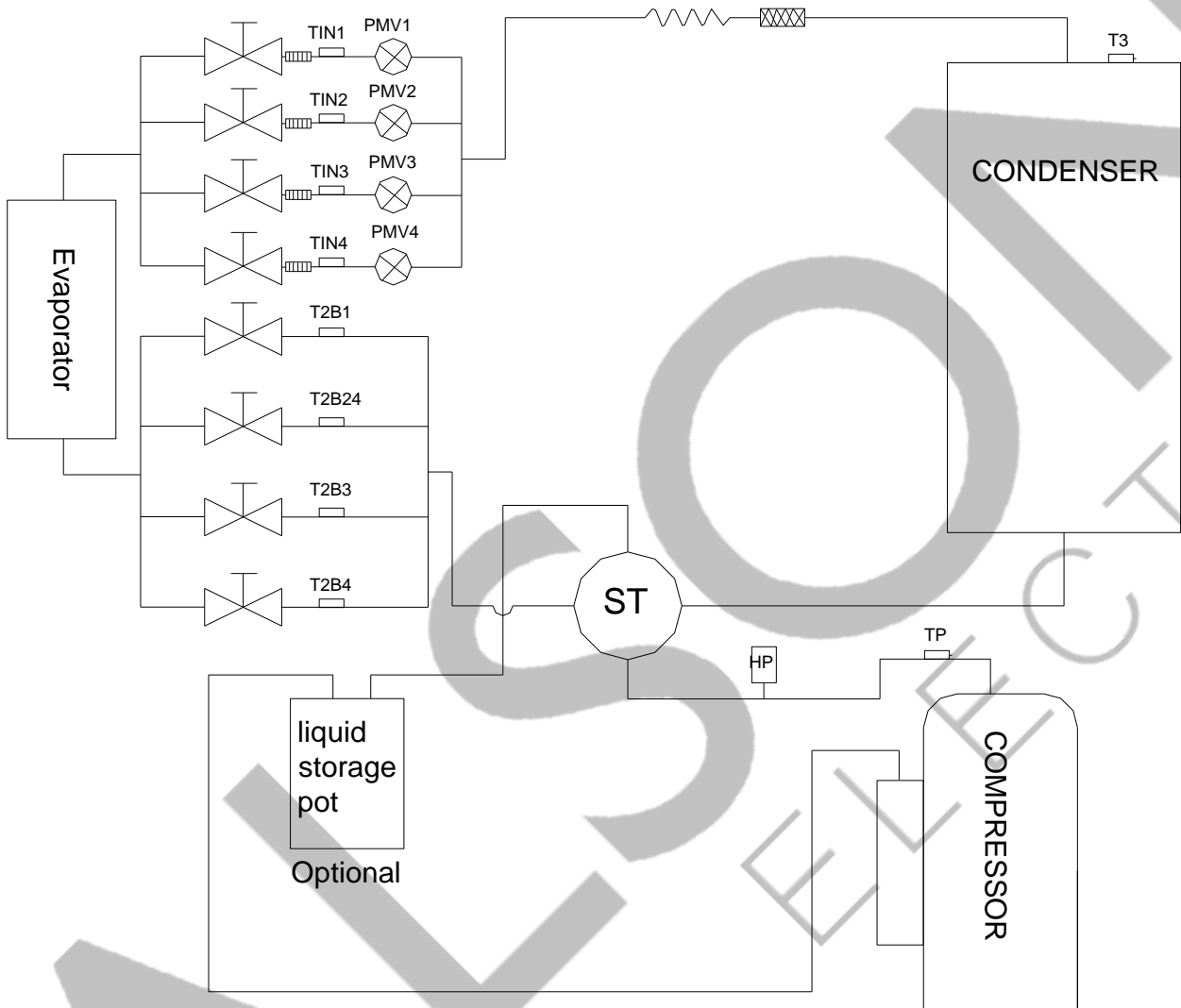

### 3. Operation details

#### Electronic Controller

##### 1. Safety Protection

- (1) Time Delay for Safety protection
  - 3 minutes delay for compressor ---The compressor is ceased for 3minutes before restarting to balance the pressure in the refrigeration cycle in order to protect the compressor.
  - 150 seconds delay for 4-way valve---The 4-way valve will be ceased for 150 seconds late after compressor to prevent the refrigerant-gas abnormal noise when the HEATING operation is OFF or switch to the other operation mode.
- (2) Discharge temperature protection  
There is a temperature sensor on discharge pipe, when temperature on discharge pipe exceeded the limit 115°C, system control will shut down the compressor and the display board will show the error code.
- (3) Lower voltage protection  
When AC voltage <160V, DC voltage<170V, unit will be shut down for protection and recover while the AC voltage >170 V, DC voltage >190V.
- (4) Over voltage protection  
When AC voltage > 275V, DC voltage >400V unit will be shut down and recover while AC voltage<255V, DC voltage<390 V.
- (5) Over current protection  
When the current of outdoor unit is overload, controller will drop the operation frequency or shut down the unit immediately and show error code.
- (6) Condenser temperature protection  
When condenser temperature $\geq 65^{\circ}\text{C}$  and keep 10s, the air conditioner will shut down, and show error code, and recover while condenser temperature<52°C and the compressor stop for 3minutes.
- (7) IPM module protection  
IPM module has high temperature & over current protection itself, if there is signal feedback to IPM, the outdoor unit will shut down, LED on outdoor PCB will show the error code.
- (8) Evaporator freeze protection.  
When evaporator temperature<2°C, the controller will drop compressor operate frequency.  
When evaporator temperature<0°C and keep 1 minute, the expand valve of the unit will stop.  
When all of the operating unit enter freeze protect, the compressor will stop and recover while evaporator temperature and stop for 3 minutes.

##### 2. "Feel" Mode Operation

- (1) When the "Feel" mode is selected, the operation mode and initial temperature set are determined by the initial room temperature at start-up of the operation except to turn off the air conditioner and operates it again.
- (2) If the unit have activate the AUTO restart, when the power off and supply again, the unit will judge the condition again and enter the "Feel" mode.
- (3) If the mode is change to "Feel" from other mode, the "Feel" mode doesn't operate until compressor stop for more than 3 minutes.

Mode	Initial Room Temperature	Initial Set Temperature
COOLING	RT=26°C	23°C
DRY	26°C > RT $\geq$ 20°C	RT-2°C
HEATING	RT < 20°C	23°C
Fan	RT < 20°C	RT

- In the “Feel” mode, when the controller receives the up or down signal of temperature, the set temperature can adjust by 1°C upper or lower. The biggest you can adjust by 2°C upper or lower.

### 3. “COOLING” Mode Operation

#### (1) Compressor frequency control

According to difference room temperature and set temperature ( $\delta t = RT - ST$ ), running frequency of compressor is controlled by electronic controller. When room temperature is much higher than set temperature, the compressor will start at a high frequency, and as room temperature goes down, the compressor running frequency will go down. When room temperature is lower than set temperature, the compressor will run at very low frequency. In general, unit will change its running frequency according to  $\delta t$  to make room temperature closing to set temperature.

#### (2) Outdoor temperature affects running frequency of the compressor

Outdoor temperature affect compressor’s running frequency. Difference inlet temperature of outdoor unit is adapted by difference compressor running frequency. While outdoor temperature is about 30°C, the compressor will run in high frequency.

If unit run in “cooling” mode and outdoor temperature is less than -2°C, the controller will shut down compressor and show error code, while the ambient temperature is over 1°C, the compressor will run automatically.

#### (3) Auto fan control in cooling mode

In cooling mode (include cooling in “Feel” mode), fan speed is determined by  $\delta t$ , as the following diagram:

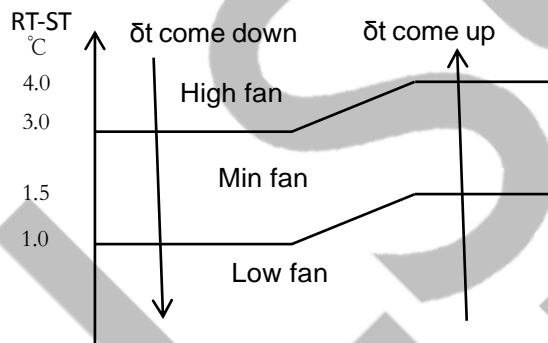

### 4. “DRY” Mode Operation

- (1) The system for DRY operation used the same refrigerant circle as the cooling one.
- (2) When the system operates in DRY mode, at first it operates in cooling mode, the set temperature (ST) is “RT-2°C”. After that, the system will operate in cooling mode with lowest fan speed. During the course of this operation, you can’t use remote controller to adjust the fan speed but you can control the vane direction.
- (3) In the dry mode, when  $RT \leq 12^\circ\text{C}$ , the compressor will stop and operates again at  $RT \geq 14^\circ\text{C}$ .

### 5. “HEATING” Mode Operation (available for Heat Pump only)

#### (1) Frequency control

Same as the frequency control in cooling mode, the running frequency of compressor is controlled by controller. Unit change its running frequency according to  $\delta t$  to make the room temperature closing to the set temperature.

#### (2) Indoor fan motor control

##### 1) Cold Air Prevention Control

- The function is intended to prevent cold air from being discharged when heating mode selected or while in defrosting.
- The indoor fan speed will be controlled as following.

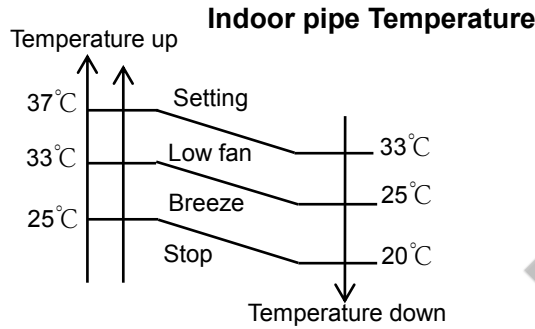

- In heating operation, if air conditioner turn off, the indoor fan motor will run most for 30 seconds since the stop of compressor.

2) Auto fan control (heating)

In heating mode (include in “feel” mode) , fan speed is determined by  $\delta t$  as the following:

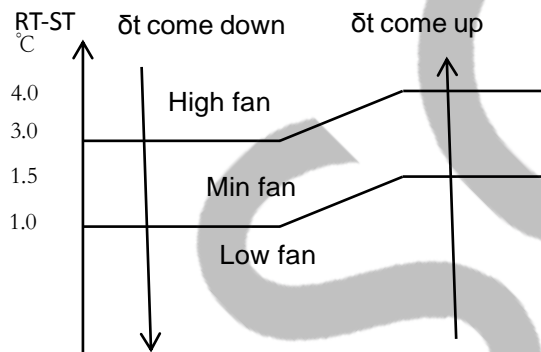

(3) 4-way valve control

In heating mode, 4-way valve will power on ahead of compressor for 8 seconds, and cut off for 2 minutes later than compressor. 4-way valve will not power off unless the machine to be switched off, mode changed or on the process of defrosting.

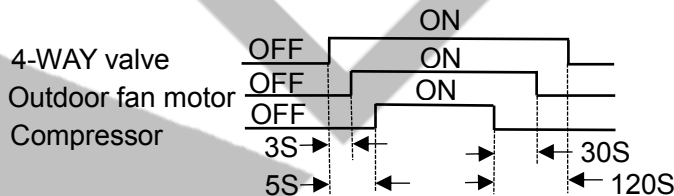

(4) Outdoor fan motor control

In heating mode, the outdoor fan motor will power on ahead of compressor 5 seconds, and cut off for 30seconds later than compressor.

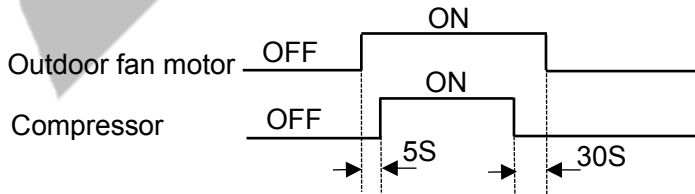

(5) Defrosting

Defrosting is controlled by the microprocessor.

When the unit operate 30 minutes accumulated and the compressor operation more than 3 minutes continuously, one of the following conditions is satisfied, unit comes into defrosting:

- When  $FrostDeg \geq -5^{\circ}C$ , and  $OPT \leq -5^{\circ}C$ , the .2 times defrosting interval time is 45 minutes.
- When  $-10^{\circ}C \leq FrostDeg < -5^{\circ}C$ , and  $OPT < FrostDeg$ , the .2 times defrosting interval time is 45 minutes.
- When  $-13^{\circ}C \leq FrostDeg < -10^{\circ}C$ , and  $OPT < FrostDeg$ , the .2 times defrosting interval time is

45 minutes.

- d. When  $-15^{\circ}\text{C} \leq \text{FrostDeg} < -13^{\circ}\text{C}$ , and  $\text{OPT} < \text{FrostDeg}$ , the .2 times defrosting interval time is 65 minutes.
- e. When  $-15^{\circ}\text{C} \leq \text{FrostDeg} < -10^{\circ}\text{C}$ , and  $\text{OPT} < \text{FrostDeg}$ , the .2 times defrosting interval time is 75 minutes.
- f. When  $\text{FrostDeg} < -15^{\circ}\text{C}$ , and  $\text{OPT} < -15^{\circ}\text{C}$ , the .2 times defrosting interval time is 75 minutes.

$$\text{FrostDeg} = C \cdot \text{OAT} - \alpha$$

OAT: Outdoor environment temperature.

When  $\text{OAT} < 0^{\circ}\text{C}$ ,  $C=0.8$ , when  $\text{OAT} \geq 0^{\circ}\text{C}$ ,  $C=0.6$

$\alpha=8$

Before the air con comes into defrosting, compressor running frequency drop down to a lower frequency firstly, then the compressor shuts down.

In defrosting, all protection function are available.

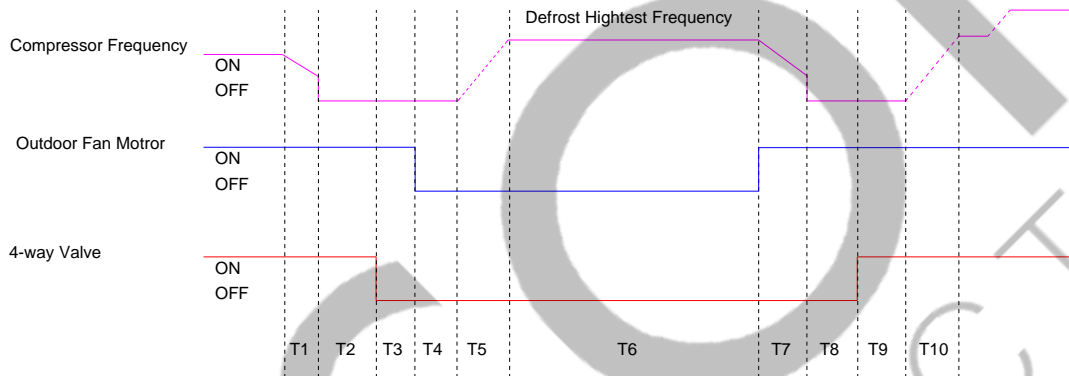

T	T1	T2	T3	T4	T5	T6	T7	T8	T9	T10
Times	Drop frequency or stop	50s	5s	5s	Rise frequency	2-11Min	Stop Defrost	50s	10s	Rise frequency

In defrosting, LED showing by winking.

No matter what AC come into or out of defrosting, indoor fan motor speed is the same as Cold Air Prevention Control.

While one of the following conditions is satisfied, unit comes out of defrosting and shifts to heating mode:

- a. Outdoor coil Temperature (OPT)  $> 5^{\circ}\text{C}$  and keeps 30 seconds.
- b. Outdoor coil Temperature (OPT)  $> 10^{\circ}\text{C}$  and keeps 2 seconds.
- c. Continue 11minutes defrost Operation.

(5) Indoor exchanger overheat protection

When Indoor exchanger Temperature (IPT) is higher than  $54^{\circ}\text{C}$ , unit comes into indoor exchanger overheat protection. The compressor drops its frequency.

If  $\text{IPT} \geq 65^{\circ}\text{C}$  and keep for 30 seconds, control system shut down compressor, and recover while IPT drop less than  $52^{\circ}\text{C}$ .

4. "SLEEP" mode

When the SLEEP button is pressed, the AC operates as following:

- The indoor fan speed is set at low speed, the power lamp and the sleep lamp is on, the display of temperature will close after 30 seconds.
- When selecting COOLING/DRY operation with SLEEP mode, the set temperature will be raised by  $1^{\circ}\text{C}$  1 hour later and by  $2^{\circ}\text{C}$  2 hour later, after 3 hours, the set temperature will be raise by  $3^{\circ}\text{C}$  and keeps 2hours. And then the temperature is Set+ $2^{\circ}\text{C}$ , after 1 hour, the temperature is set temperature and keep.
- When selecting HEATING operation with SLEEP mode, the set temperature will be dropped by  $1^{\circ}\text{C}$  1 hour later and  $2^{\circ}\text{C}$  2 hours later, after 3 hours, the set temperature will be dropped by

3°C and keep 2 hours. And then the temperature is Set-2°C, after 1 hour, the temperature is set temperature and keep.

## 5. EMERGENCY Operation

When the EMERGENCY Operation switch is pressed, "Beep" a short sound, COOLING mode is selected, two short sound the HEATING mode selected, and a long sound the unit off of 3s.

During the unit operation in emergency operation, when the unit receive the signal of remote controller, the unit will operates by remote.

When the remote controller missing, failed or the batteries run down, press the EMERGENCY Operation switch on front of the indoor unit for function test.

NOTE: Do not press the EMERGENCY Operation switch during normal operation.

## 6. AUTO-RESTART Function (Option)

While air conditioner is operating in one mode, all of its operation data, such as working mode, preset temperature etc. would be memorized into IC by main PCB. If power supply cut off due to reasons and recover again, the AUTO-RESTART function will set synchronously and the air conditioner would work at the same mode as before.

### Auto-restart Pre-setting (optional):

If Auto-restart function is needed, follow the steps below to activate this function:

- 1) Pulling the air-con's plug out of socket.
- 2) Pressing and holding the Emergency button (ON/OFF) on the indoor, then insert the plug into the socket again.
- 3) Keep pressing the Emergency button for more than 10 seconds until three short beeps heard, the Auto-restart function been activated.
- 4) When the unit in operation, press the timer button 10 times in 8s, the Auto-restart function will be active, if the Auto-restart is active, the Auto-restart off.

## 7. Water pump control(cassette and duct type)

When the unit operates in cool or dry mode, the water pump operates, once the compressor off or change to other mode, the water pump stop after 10 minutes.

Anytime, when the unit check the water full, the water pump operates, the unit stop and display the water full code. When the water full eliminate, the water pump will stop after 10 minutes.

When check the water pump switch open for 8 seconds continuous, enter water full protection, and check the water pump switch on for 180 seconds continuous, the water full protection exit.

## 8. Protection and Failure Display

- When protection display is available, controller will show error code, digital LED shows error code and setting temperature by turns.
- If there is more than one failure, it will show error codes according to the error list sequence.
- To insure the signal communication of indoor and outdoor unit, any failure code relates to outdoor unit will remain display for 2 minutes maximum after it's recovered.
- Among all the failure codes, sensor failure can be recovery automatically once it comes normal.



● **Error list**

Failure Type	Indoor LED Code	CASSETTE				Outdoor light blink time (n)
		LED1	LED2	LED3	LED4	
Indoor and outdoor communication failure	E0	●	●	●	◎	7
Outdoor communication failure	EC	◎	◎	●	●	15
Indoor room temperature sensor (IRT)	E1	●	●	◎	●	25
Indoor coil temperature sensor (IPT)	E2	●	●	◎	◎	26
Outdoor coil temperature sensor (OPT)	E3	●	◎	●	●	10
IPM over current protect	E4	●	◎	●	◎	40
Compressor phase-deficient operation						34
Model configuration wrong	E5	●	◎	◎	●	29
Indoor fan motor fault	E6	●	◎	◎	◎	21
Outdoor temperature sensor	E7	◎	●	●	●	9
Exhaust temp. sensor	E8	◎	●	●	◎	11
IPM drive and module fault	E9	◎	●	◎	●	30
Outdoor fan motor fault (DC motor)	EF	◎	◎	◎	◎	16
Current sensor fault	EA	◎	●	◎	◎	13
Indoor EEPROM fault	EE	◎	◎	●	◎	27
Outdoor EEPROM fault	EE	◎	◎	◎	●	19
Temp. switch fault ( on top of the compressor)	EP	-	-	-	-	8
Voltage sensor fault	EU	○	●	●	◎	12
Suction temperature sensor fault	EH	-	-	-	-	18
Outlet temperature sensor A fault	Ey	○	●	◎	●	47
Outlet temperature sensor B fault						48
Inlet temperature sensor A fault	En	○	●	◎	◎	51
Inlet temperature sensor B fault						52

● Protection display code list:

Protection Type	Indoor LED Code	CASSETTE				Outdoor light blink time (n)
		LED1	LED2	LED3	LED4	
Module protection (hardware control)	P0	-	-	-	-	1
lower voltage protection	P1	○	●	●	○	2
Overcurrent protection	P2	○	●	○	●	3
Discharge over temperature protection	P4	○	○	●	●	4
Too cool protection in cooling mode	P5	-	-	-	-	32
Overheat protection in cooling mode	P6	○	○	○	●	5
Overheat protection in heating mode	P7	○	○	○	○	33
Outdoor over temperature / lower temperature protection	P8	-	-	-	-	31
Drive protection (software control )	P9	-	-	-	-	6
Model different	PA	●	●	○	○	-
Water full protect	D3	●	○	○	◎	-
High pressure protection	H1	-	-	-	-	-

○--light ●--off ◎—flash

- Outdoor failure display

There is a LED on outdoor power board, it blinks 1s ON and 1s OFF while compressor standby and it always light (ON) while compressor running; If there is failure happened on ODU, The indicator (LED) alerts the fault in a cycle as such that it is bright for 0.5 seconds, dark for 0.5 seconds, blinks “n” times and then dark for 3 seconds. For details as table below.

Display on outdoor power source board:

blink time (n)	Failure
1	IPM protection
2	Over voltage /lower voltage
3	Overcurrent
4	Exhaust over temperature protection
5	Outdoor coil over temperature protection
6	Drive fault and protection (V1, VP1)
7	Communication fault with indoor unit
8	Compressor overheat fault (compressor top switch)
9	Short-circuit / open-circuit fault of outdoor temperature sensor
10	Short circuit / open-circuit fault of outdoor heat exchanger temperature
11	Short-circuit / open-circuit fault of exhaust temperature sensor
12	Voltage sensor fault
13	Current sensor fault
14	IPM fault
15	Communication fault between power source board and IPM
16	No feedback from DC fan motor(outdoor unit)
17	Defrost state

## 5. Wiring diagram

### INDOOR UNIT:

Wall split type: VAC - UI

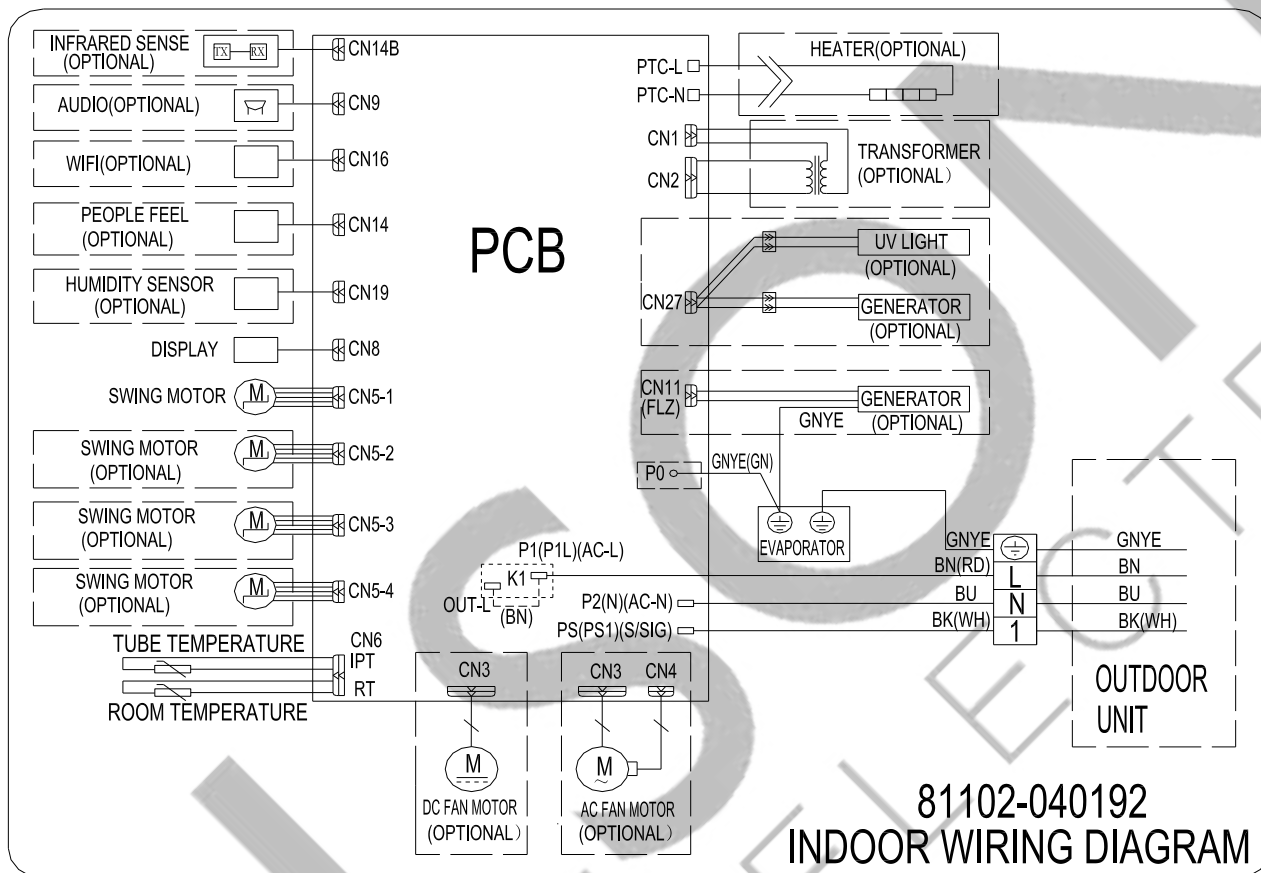

### Cassette, Duct type:

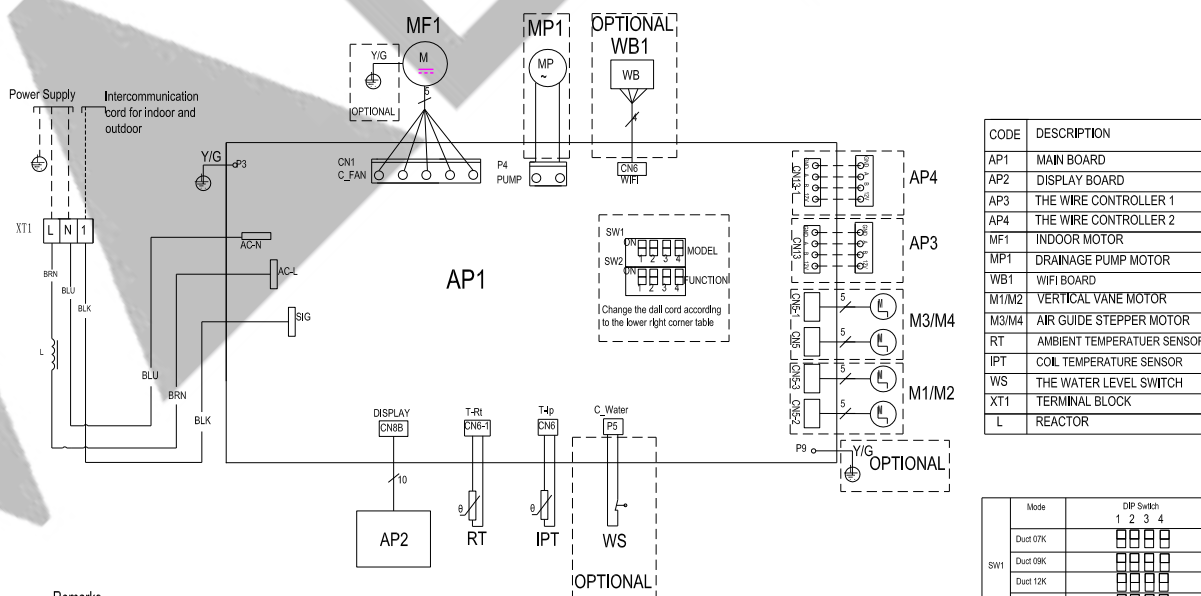

**Remarks:**

1. drainage pump, the water level switch is optional;
2. " " for the dial contact location, the type and function to dial contact position in the table shall prevail;

CODE	DESCRIPTION
AP1	MAIN BOARD
AP2	DISPLAY BOARD
AP3	THE WIRE CONTROLLER 1
AP4	THE WIRE CONTROLLER 2
MF1	INDOOR MOTOR
MP1	DRAINAGE PUMP MOTOR
WB1	WiFi BOARD
M1/M2	VERTICAL VANE MOTOR
M3/M4	AIR GUIDE STEPPER MOTOR
RT	AMBIENT TEMPERATURE SENSOR
IPT	COIL TEMPERATURE SENSOR
WS	THE WATER LEVEL SWITCH
XT1	TERMINAL BLOCK
L	REACTOR

	Mode	DIP Switch			
		1	2	3	4
SW1	Duct 07K	□	□	□	□
	Duct 09K	□	□	□	□
	Duct 12K	□	□	□	□
	Duct 18K	□	□	□	□
	Duct 21K	□	□	□	□
SW11	Cassette 07K	□	□	□	□
	Cassette 09K	□	□	□	□
	Cassette 12K	□	□	□	□
	Cassette 18K	□	□	□	□

**OUTDOOR UNIT**

**ONE TO 2 TYPE: VAM240 -VAM252**

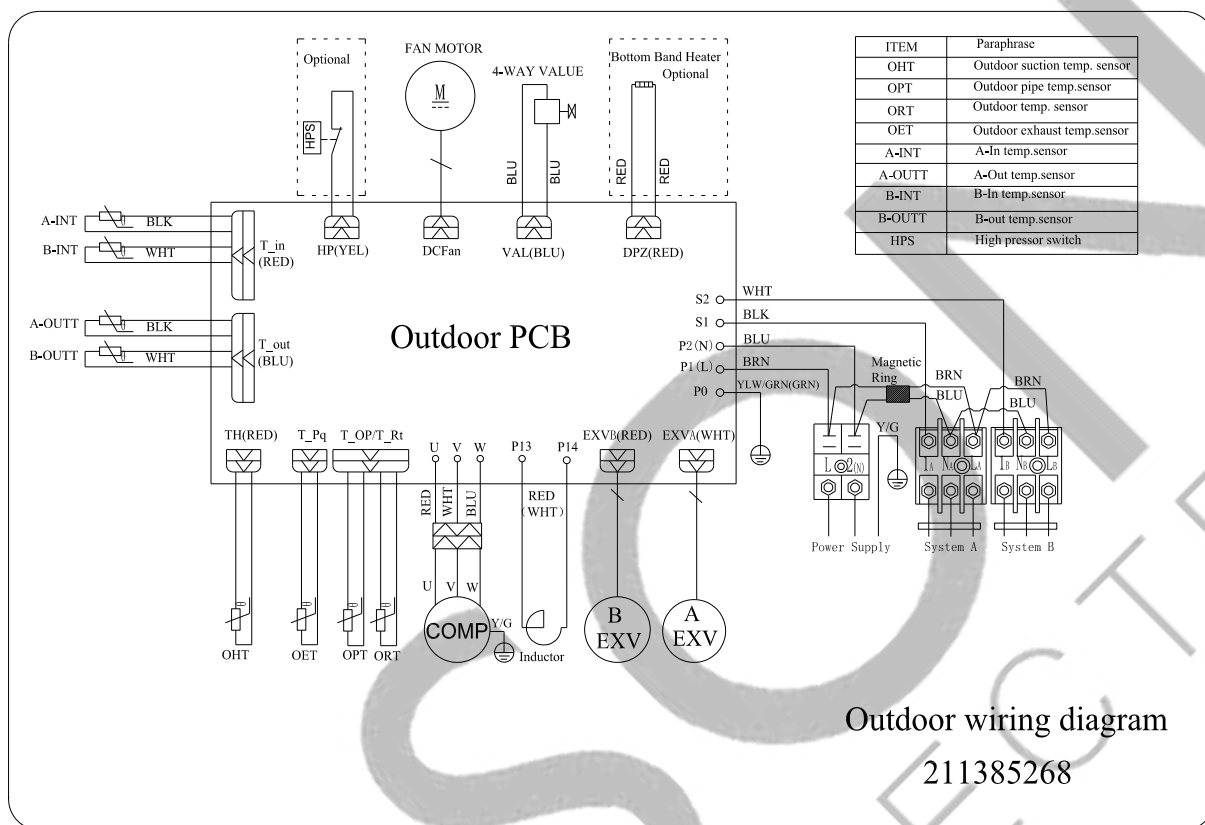

**ONETO 3TYPE: VAM362**

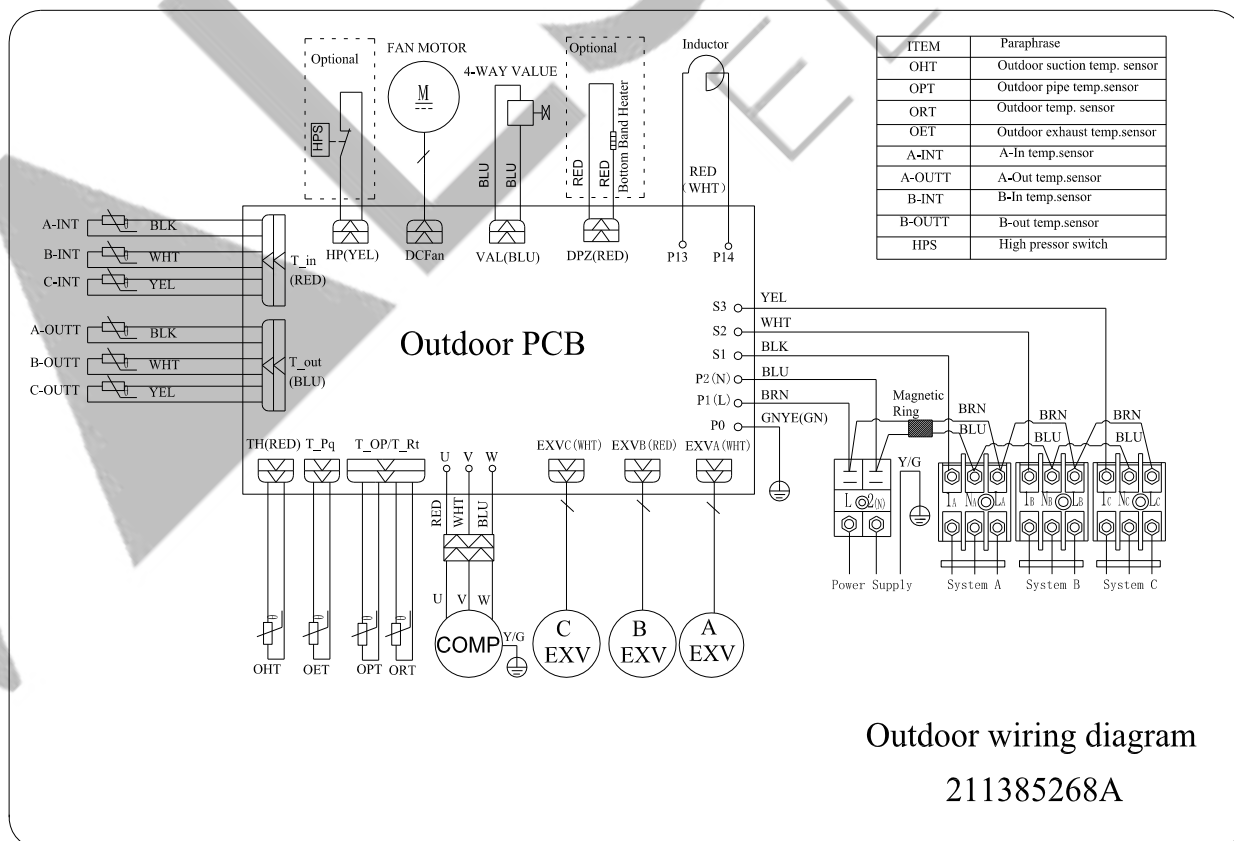

## 6. Precaution

### 6.1 SAFETY RULES AND RECOMMENDATIONS FOR THE INSTALLATION

- Read this guide before installing and using the appliance.
- During the installation of the indoor and outdoor units the access to the working area should be forbidden to children.  
Unforeseeable accidents could happen.
- Make sure that the base of the outdoor unit is firmly fixed.
- Check that air cannot enter the refrigerant system and check for refrigerant leaks when moving the air conditioner.
- Check that air cannot enter the refrigerant system and check for refrigerant leaks when moving the air conditioner.
- The ratings of the fuse installed in the built in-control unit are T 5A / 250V.
- The user must protect the indoor unit with a fuse of suitable capacity for the maximum input current or with another overload protection device.
- Ensure that the mains voltage corresponds to that stamped on the rating plate. Keep the switch or power plug clean. Insert the power plug correctly and firmly into the socket, thereby avoiding the risk of electric shock or fire due to insufficient contact.
- Check that the socket is suitable for the plug, otherwise have the socket changed.
- The appliance must be fitted with means for disconnection from the supply mains having a contact separation in all poles that provide full disconnection under over voltage category III conditions, and these means must be incorporated in the fixed wiring in accordance with the wiring rules.
- The air conditioner must be installed by professional or qualified persons. Do not install the appliance at a distance of less than 50 cm from inflammable substances (alcohol, etc.) Or from pressurized containers (e.g. spray cans).
- If the appliance is used in areas without the possibility of ventilation, precautions must be taken to prevent any leaks of refrigerant gas from remaining in the environment and creating a danger of fire.
- The packaging materials are recyclable and should be disposed of in the separate waste bins. Take the air conditioner at the end of its useful life to a special waste collection center for disposal.
- Only use the air conditioner as instructed in this booklet. These instructions are not intended to cover every possible condition and situation. As with any electrical household appliance, common sense and caution are therefore always recommended for installation, operation and maintenance.
- The appliance must be installed in accordance with applicable national regulations.
- Before accessing the terminals, all the power circuits must be disconnected from the power supply.
- The appliance shall be installed in accordance with national wiring regulations.
- This appliance can be used by children aged from 8 years and above and persons with reduced physical, sensory or mental capabilities or lack of experience and knowledge if they have been given supervision or instruction concerning use of the appliance in a safe way and understand the hazards involved.

Children shall not play with the appliance. Cleaning and user maintenance shall not be made by children without supervision.

## 6.2 SAFETY RULES AND RECOMMENDATIONS FOR THE USER

- Do not try to install the conditioner alone; always contact specialized technical personnel. Cleaning and maintenance must be carried out by specialized technical personnel. In any case disconnect the appliance from the mains electricity supply before carrying out any cleaning or maintenance.
- Ensure that the mains voltage corresponds to that stamped on the rating plate. Keep the switch or power plug clean. Insert the power plug correctly and firmly into the socket, thereby avoiding the risk of electric shock or fire due to insufficient contact.
- Do not pull out the plug to switch off the appliance when it is in operation, since this could create a spark and cause a fire, etc.
- This appliance has been made for air conditioning domestic environments and must not be used for any other purpose, such as for drying clothes, cooling food, etc.
- The packaging materials are recyclable and should be disposed of in the separate waste bins. Take the air conditioner at the end of its useful life to a special waste collection center for disposal.
- Always use the appliance with the air filter mounted. The use of the conditioner without air filter could cause an excessive accumulation of dust or waste on the inner parts of the device with possible subsequent failures.
- The user is responsible for having the appliance installed by a qualified technician, who must check that it is earthed in accordance with current legislation and insert a thermomagnetic circuit breaker.
- The batteries in remote controller must be recycled or disposed of properly. Disposal of Scrap Batteries --- Please discard the batteries as sorted municipal waste at the accessible collection point.
- Never remain directly exposed to the flow of cold air for a long time. The direct and prolonged exposition to cold air could be dangerous for your health. Particular care should be taken in the rooms where there are children, old or sick people.
- If the appliance gives off smoke or there is a smell of burning, immediately cut off the power supply and contact the Service Centre.
- The prolonged use of the device in such conditions could cause fire or electrocution.
- Have repairs carried out only by an authoritative Service Centre of the manufacturer. Incorrect repair could expose the user to the risk of electric shock, etc.
- Unhook the automatic switch if you foresee not to use the device for a long time. The airflow direction must be properly adjusted.
- The flaps must be directed downwards in the heating mode and upwards in the cooling mode.
- Only use the air conditioner as instructed in this booklet. These instructions are not intended to cover every possible condition and situation. As with any electrical household appliance, common sense and caution are therefore always recommended for installation, operation and maintenance.
- Ensure that the appliance is disconnected from the power supply when it will remain inoperative for a long period and before carrying out any cleaning or maintenance.

- Selecting the most suitable temperature can prevent damage to the appliance.

### 6.3 SAFETY RULES AND PROHIBITIONS

- Do not bend, tug or compress the power cord since this could damage it. Electrical shocks or fire are probably due to a damaged power cord. Specialized technical personnel only must replace a damaged power cord.
- Do not use extensions or gang modules.
- Do not touch the appliance when barefoot or parts of the body are wet or damp.
- Do not obstruct the air inlet or outlet of the indoor or the outdoor unit. The obstruction of these openings causes a reduction in the operative efficiency of the conditioner with possible consequent failures or damages.
- In no way alter the characteristics of the appliance.
- Do not install the appliance in environments where the air could contain gas, oil or sulphur or near sources of heat.
- This appliance is not intended for use by persons (including children) with reduced physical, sensory or mental capabilities, or lack of experience and knowledge, unless they have been given supervision or instruction concerning use of the appliance by a person responsible for their safety.
- Do not climb onto or place any heavy or hot objects on top of the appliance.
- Do not leave windows or doors open for long when the air conditioner is operating.
- Do not direct the airflow onto plants or animals.
- A long direct exposition to the flow of cold air of the conditioner could have negative effects on plants and animals.
- Do not put the conditioner in contact with water. The electrical insulation could be damaged and thus causing electrocution.
- Do not climb onto or place any objects on the outdoor unit
- Never insert a stick or similar object into the appliance. It could cause injury.
- Children should be supervised to ensure that they do not play with the appliance. If the supply cord is damaged, it must be replaced by the manufacturer, its service agent or similarly qualified persons in order to avoid a hazard.

## 7. Names of parts

### Wall split type

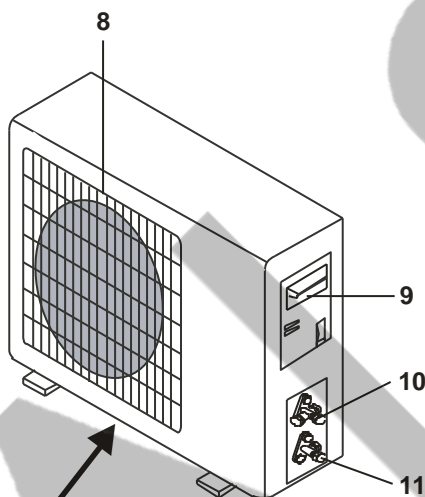
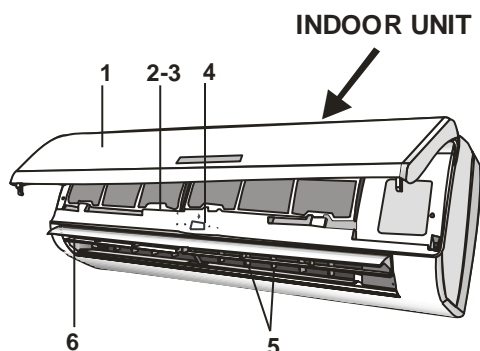

OUTDOOR UNIT

Indoor unit	
No.	Name
1	Front panel
2	Air filter
3	Special filter(option)
4	Display PCB
5	Vertical vane
6	Horizontal vane
7	Remote controller

Outdoor unit	
No.	Name
8	Air outlet grille
9	Electronic box cover
10	2-way valve
11	3-way valve

### Display

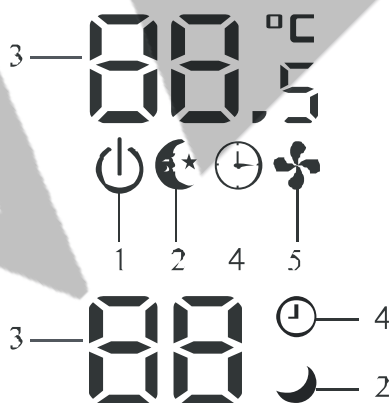

No.	Name
1	Power
2	Sleep
3	Temperature display
4	Timer
5	Run



### Cassette type

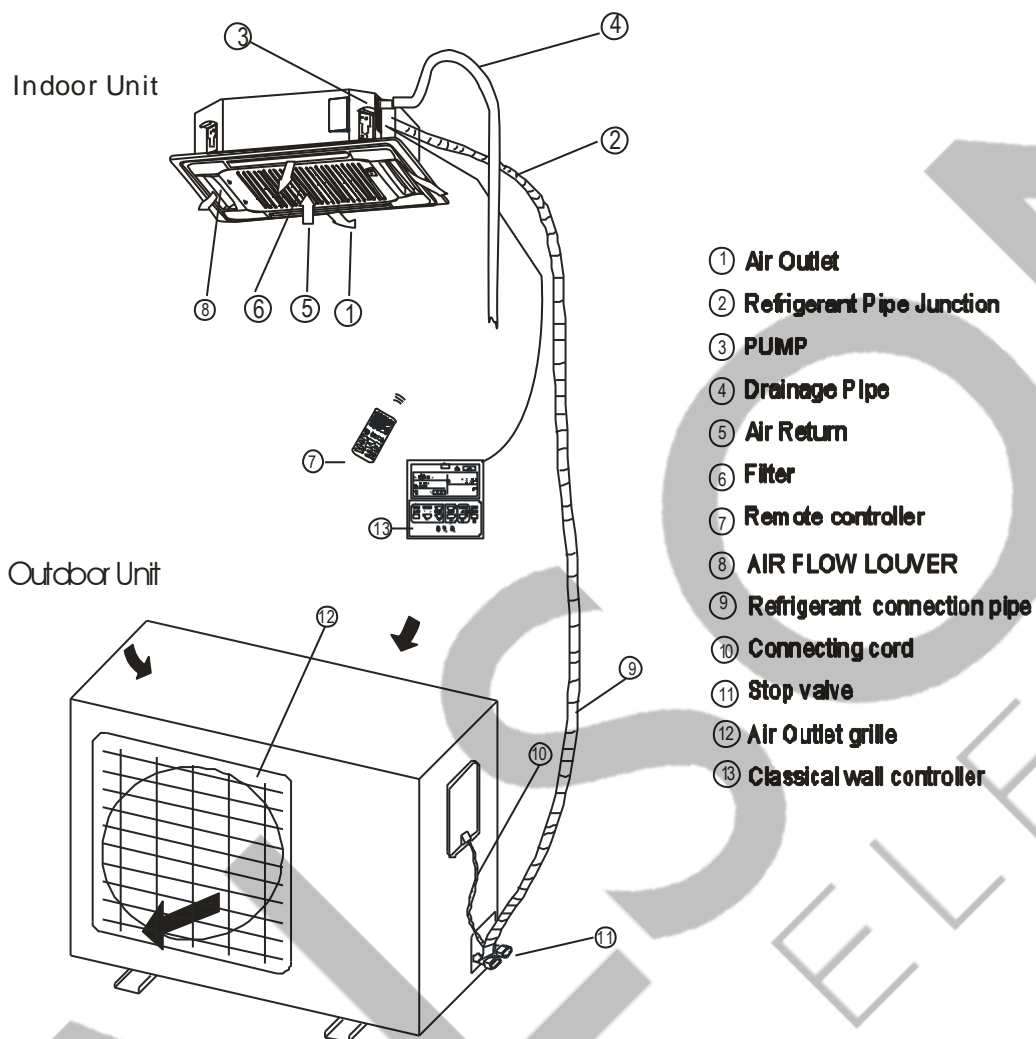

### Display



INFRARED SIGNAL RECEIVER

Outdoor unit		
No.	Name	
8		Electronic box cover
9		2-way valve
10		3-way valve

LIGHTING ON :



Timer indicator



Operation indicator



PRE-DEF indicator



Pump indicator

Timer indicator : ON when preset time for switching ON/OFF the unit

Operation indicator : ON when the unit is power on

PRE-DEF indicator : ON when the unit prevent cool air flowing in room.

Pump indicator : ON when the water level is high

### Duct type

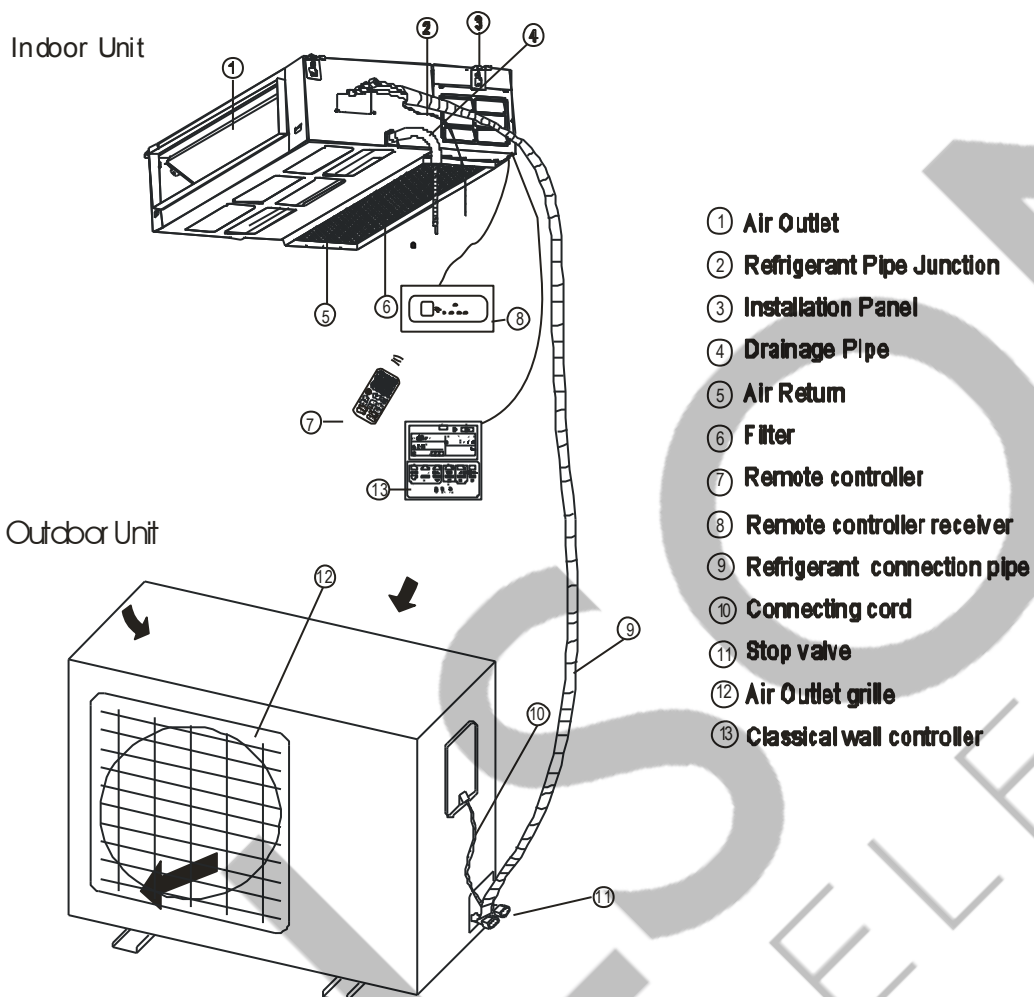

### DISPLAY

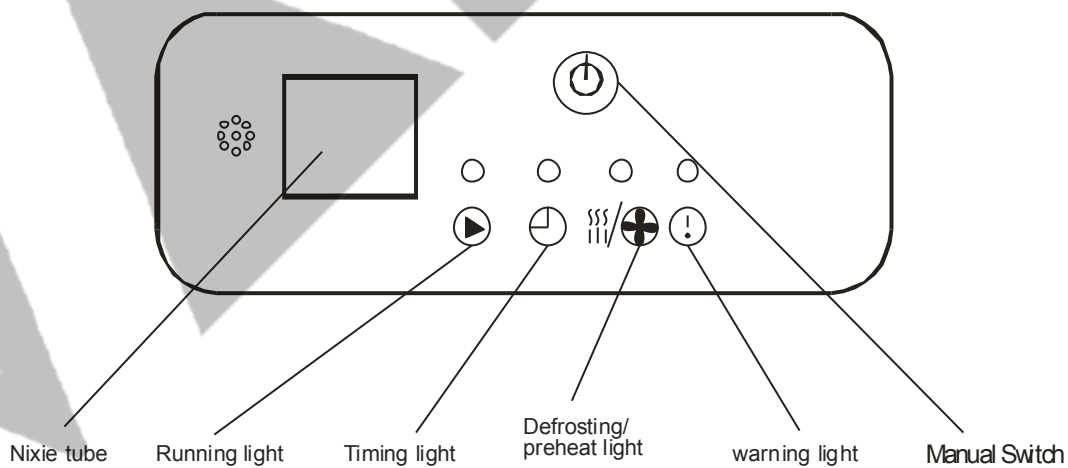

## 8. Installation manual

### 8.1 Installation Details

#### Connecting pipe length

Model	Pipe size(Inch)	
	Liquid	Gas
9K	1/4	3/8
12K	1/4	3/8
18K	1/4	1/2

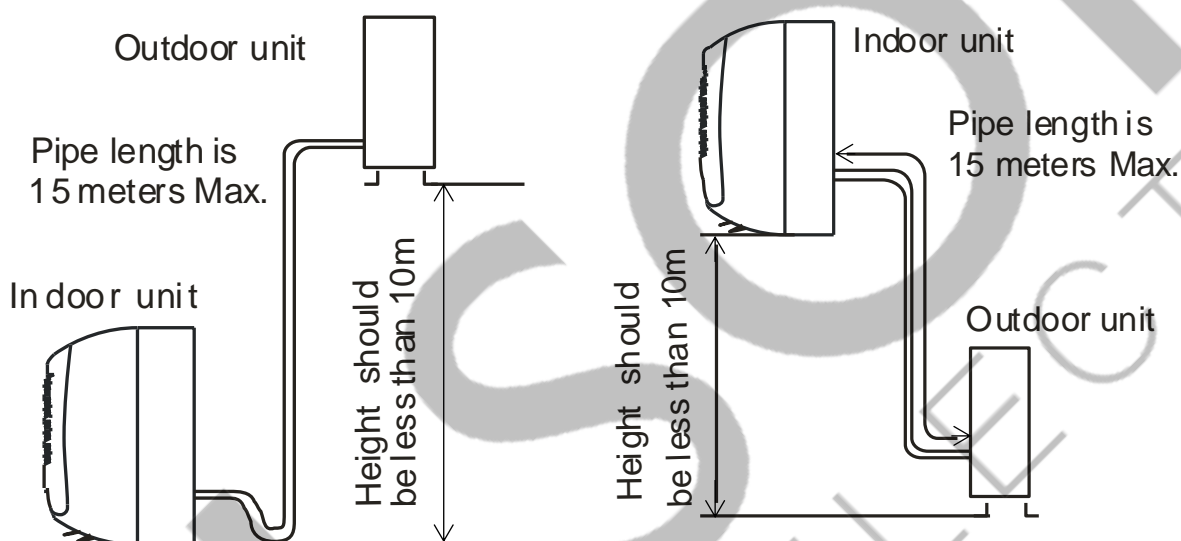

Mode	Standard length: m	Refrigerant piping Max. length: m	Additional refrigerant Calculation: $xg/m(A-5m)$
9K	5.0	15	15g/m
12K	5.0	15	15g/m
18K	5.0	15	20g/m

#### Connecting cables

The power cord should be selected according to the following specifications sheet.

Appliance Amps	Wire Size
5	AWG21/0.75 mm <sup>2</sup>
10	AWG18/1.0 mm <sup>2</sup>
13	AWG15 /1. 5 mm <sup>2</sup>
18	AWG14/1.6 mm <sup>2</sup>
25	AWG12/2.0 mm <sup>2</sup>
30	AWG10/2.5 mm <sup>2</sup>

## 8.2 Installation for the first time

### Indoor unit

#### Wall type:

- Install the indoor unit level on a strong wall that is not subject to vibrations
- The inlet and outlet ports should not be obstructed: the air should be able to blow all over the room.
- Do not install the unit near a source of heat, steam, or flammable gas.
- Install the unit near an electric socket or private circuit.
- Do not install the unit where it will be exposed to direct sunlight.
- Install the unit where connection between indoor and outdoor unit is as easy as possible.
- Install the unit where it is easy to drain the condensed water.
- Check the machine operation regularly and leave the necessary spaces as shown in the picture.
- Install the indoor unit where the filter can be easily accessible.
- Install the indoor unit in the room to be air conditioning, avoiding to installation in corridors or communal areas.

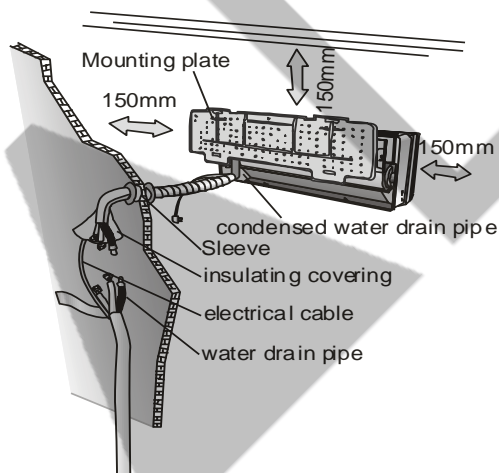

- Install the indoor unit at a height of at least 2.5m from the ground.

#### Cassette type:

- Be sure to lead the refrigerant pipes, drain pipes and connection wires out to its connection location before hanging the unit if the opening on the ceiling has been decided.
- Confirm sizes of the indoor unit and ceiling opening with the attached installation paper pattern. (Please fix the paper pattern below the body with M5X16 screws (4).

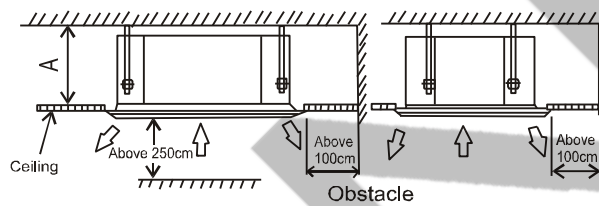

A > 330mm

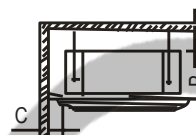

Wall material	Flammable material	Fire-proof or nonflammable materials	Fire-proof structure
B	Above 5cm	Above 5cm	Above 5cm
C	Above 100cm	Above 100cm	-

#### Duct

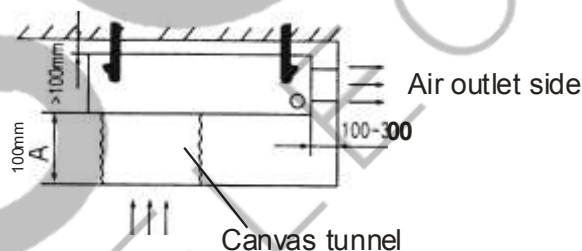

#### OUTDOOR UNIT

- Do not install the outdoor unit near sources of heat, steam or flammable gas.
  - Do not install the unit in too windy or dusty places.
  - Do not install the unit where people often pass. Select a place where the air discharge and operating sound level will not disturb the neighbours.
  - Avoid installing the unit where it will be exposed to direct sunlight (other wise use a protection, if necessary, that should not interfere with the air flow).
  - Leave the spaces as shown in the picture for
  - The air to circulate freely.
  - Install the outdoor unit in a safe and solid place.
  - If the outdoor unit is subject to vibration, place rubber gaskets onto the feet of the unit.
- Minimum space to be left (mm) showing in the picture.

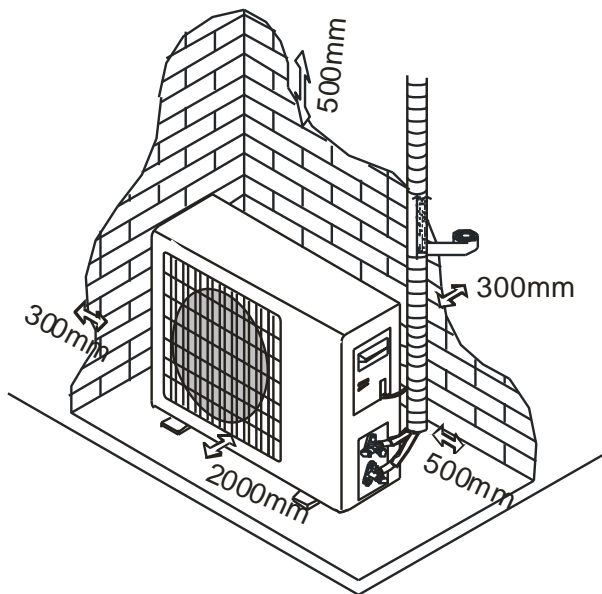

To install, proceed as follows:

**8.2.1 Installation of the mounting plate.**

**Wall split type:**

1. By using a level, put the mounting plate in a perfect square position vertically and horizontally.
2. Drill 32mm deep holes in the wall to fix the plate.
3. Insert the plastic anchors into the hole.
4. Fix the mounting plate by using the provided tapping screws.
5. Check that the mounting plate is correctly fixed.

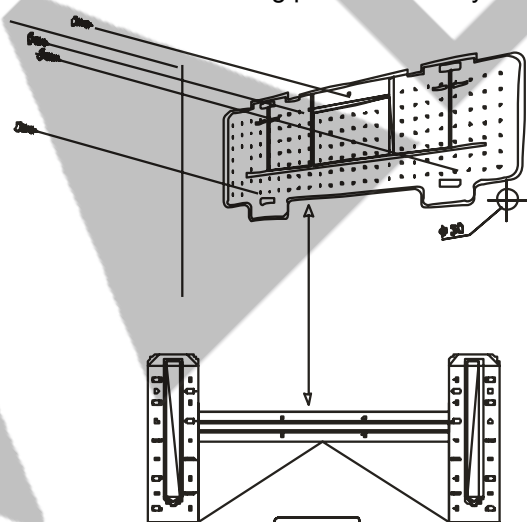

**Note:** The shape of the mounting plate may be different from the one above, but installation method is similar.

**Cassette and Duct type:**

**Wooden construction**

Put the square timber over the roof beam, then install the

hanging screw bolts.

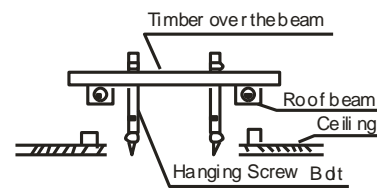

**For finished concrete bricks**

Install the hanging hook with expansible bolt into the concrete deep to 45~50mm to prevent loose.



**New Concrete Bricks**

Inlaying or embedding the screw bolts.

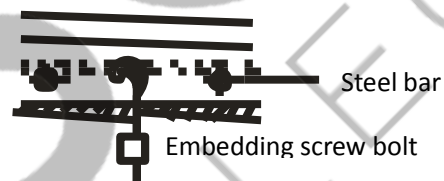
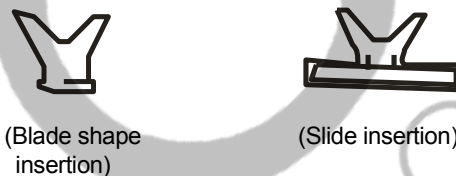

(Pipe hanging and embedding screw bolt)

**Steel roof beam structure**

Install the supporting angle steel.

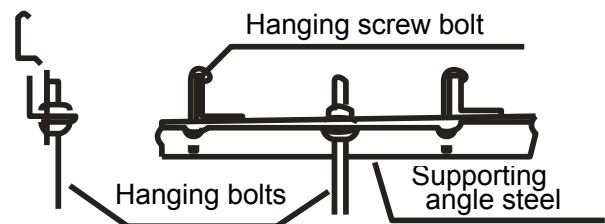

**Overhanging the indoor unit**

Adjust the gasket (down side) to 90mm over the ceiling.

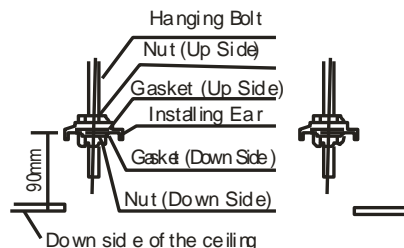

Install the hanging bolt into T groove of the hanging tool. Overhang the indoor unit and ensure it is level using a level indicator.

**cassette**

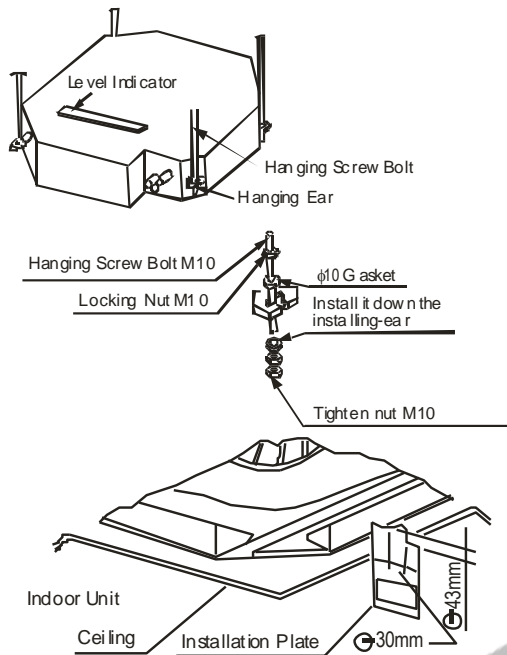

**Duct**

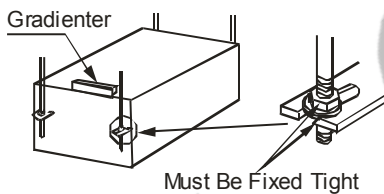

**How to mount outlet pipe.**

- Generally, we have two types of outlet pipe available, i.e. rectangular or round ones.
- Rectangular air conduit can be directly connected to air outlet of indoor unit by rivets. For outlet dimensions, see outline drawing of the unit.
- Round air conduit should be connected to a piece of transitional air conduit before it is connected to air outlet of indoor unit, the other end of it can be separately connected to air conduit window or connected to air conduit window after air flow diversion, and the total length should not be over 6m. As shown in figure below, air speeds at all air outlets should be set to basically consistent so as to meet the room air-conditioning requirements.

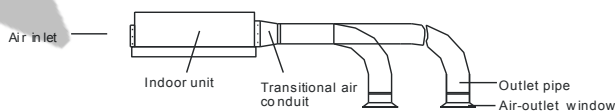

**Installation method for return air pipe**

- In case sidewise air intake is adopted, return air pipe should be fabricated and rivet-connected to return air orifice, and the other

end of it should be connected to return air window.

- In case of underside air intake, purchase or fabricate a section of pleated canvas air conduit serving as transition joint for return air orifice and return air window. in this way, it can be freely adjusted according to height of indoor ceiling board; in addition, during operation of the unit, canvas air conduit may avoid vibration of ceiling board, as shown in figure below.

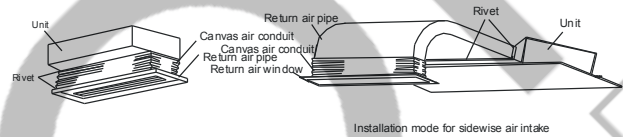

**8.2.2 Drilling a hole in the wall for the piping**

- 1) Decide where to drill the hole in the wall for the piping (if necessary) according to the position of the mounting plate
- 2) Install a flexible flange through the hole in the wall to keep the latter intact and clean. The hole must slope downwards towards the exterior.

Note: Keep the drain pipe down towards the direction of the wall hole, otherwise leakage may occur.

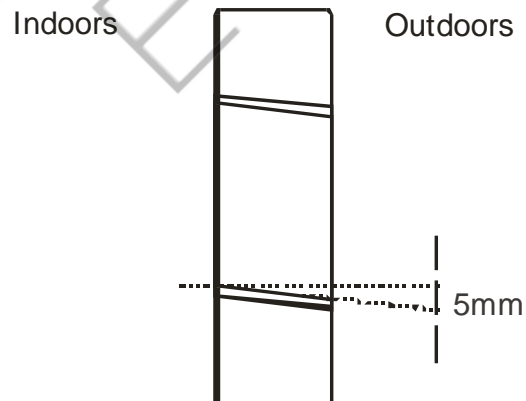

**8.2.3 Electrical connections---Indoor unit**

- 1).Lift the front panel.
- 2).Take off the cover as indicated in the picture (by removing a screw or by breaking the hooks).
- 3).For the electrical connections, see the circuit diagram on the right part of the unit under the front panel.
- 4).Connect the cable wires to the screw terminals by following the numbering, Use wire size suitable to the electric power input (see name plate on the unit) and according to all current national safety code requirements.

- 5).The cable connecting the outdoor and indoor units must be suitable for outdoor use.
- 6).The plug must be accessible also after the appliance has been installed so that it can be pulled out if necessary.
- 7).An efficient earth connection must be ensured.
- 8).If the power cable is damaged, it must be replaced by an authorized Service Centre.

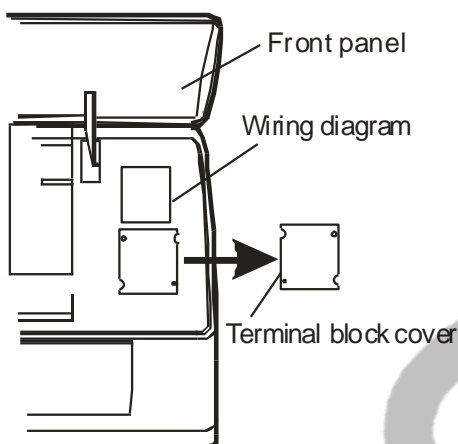

### 8.2.4 Refrigerant piping connection

The piping can be run in the 3 directions indicated by numbers in the picture. When the piping is run in direction 1 or 3, cut a notch along the groove on the side of the indoor unit with a cutter.

Run the piping in the direction of the wall hole and bind the copper pipes, the drain pipe and the power cables together with the tape with the drain pipe at the bottom, so that water can flow freely.

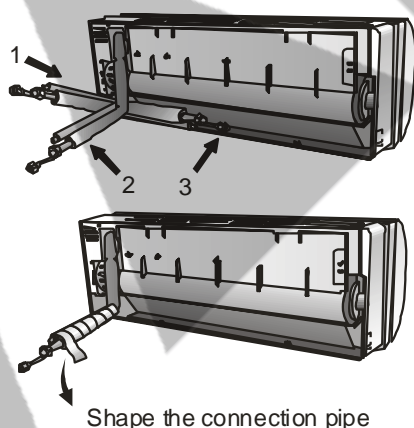

### 8.2.5 Connecting the pipes.

- Do not remove the cap from the pipe until connecting it, to avoid dampness or dirt from entering.
- If the pipe is bent or pulled too often, it will become stiff. Do not bend the pipe more than three times at one point.

- When extending the rolled pipe, straighten the pipe by unwinding it gently as shown in the picture.

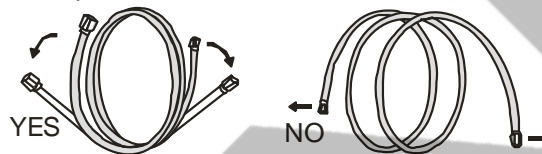

Extending the rolled pipe

### 8.2.6 Connections to the indoor unit

- 1).Remove the indoor unit pipe cap (check that there is no debris inside).
- 2).Insert the flare nut and create a flare at the extreme end of the connection pipe.
- 3).Tighten the connections by using two wrenches working in opposite directions.

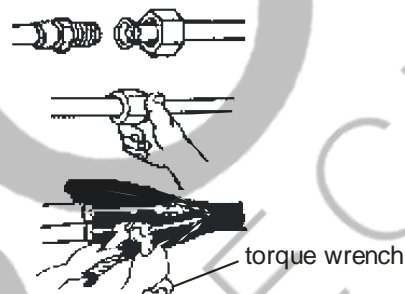

### 8.2.7 Indoor unit condensed water drainage

The indoor unit condensed water drainage is fundamental for the success of the installation.

- 1).Place the drain hose below the piping, taking care not to create siphons.
  - 2).The drain hose must slant downwards to aid drainage.
  - 3).Do not bend the drain hose or leave it protruding or twisted and do not put the end of it in water. If an extension is connected to the drain hose, ensure that it is lagged when it passes into the indoor unit.
  - 4).If the piping is installed to the right, the pipes, power cable and drain hose must be lagged and secured onto the rear of the unit with a pipe connection.
- Insert the pipe connection into the relative slot.
  - Press to join the pipe connection to the base.

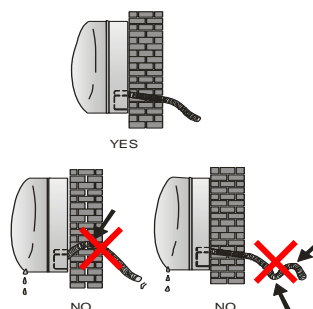

### For Cassette and Duct type

- The drain pipe of indoor unit must have the heat insulation , or it will condense dew, as well as the connections of the indoor unit.
- The declivity of the drain pipe downwards should not be over 1/100, and no winding and bending.
- The total length of the drain pipe when pulled out transversely shall not exceed 20m , when the pipe is over long, a prop stand must be installed every 1.5 to 2m to prevent winding.
- Refer to the following figures about the installation of the pipes.
- Do not impose any pressure on the connection part of the drainage pipe.

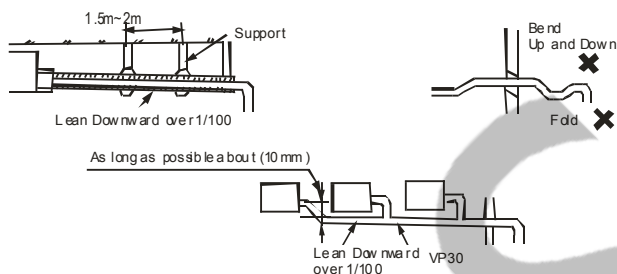

### 8.2.8 Electronic connections of outdoor unit

1. Take the cover away.
2. Connect the cable wires to the terminal board using the same numbering as in the indoor unit.
3. For the electrical connections, see the wiring diagram on the back of the cover
4. Fasten the cables with a cable-clamp.
5. An efficient earth connection must be ensured.
6. Replace the covers.

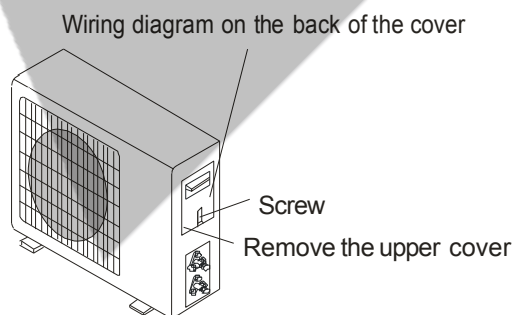

Outdoor unit

### 8.2.9 Connecting the pipe of outdoor unit

Screw the flare nuts to the outdoor unit coupling with the same tightening procedures described for the indoor unit.

Note: If the tightening torque is not sufficient, there will probably be some leakage. With excessive

tightening torque there will also be some leakage, as the flange could be damaged.

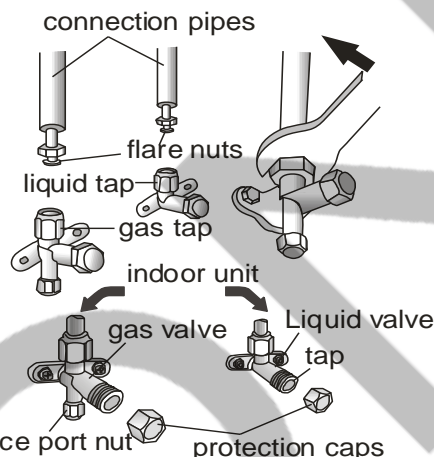

### 8.2.10 Bleeding

Air and humidity left inside the refrigerant circuit can cause compressor malfunction. After having connected the indoor and outdoor units, bleed the air and humidity from the refrigerant circuit by using a vacuum pump.

The air and humidity left inside the refrigerant circulation can cause compressor malfunction. After having connected the indoor and outdoor units, bleed the air and humidity from the refrigerant circulation using a vacuum pump.

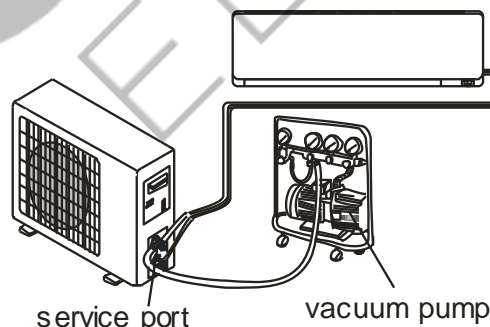

### Notice

According to installation conditions, overlarge wrenched Torch will destroy the nut. (Unit. N.cm)

Pipe	Tightening torque(N.M)
1/4"	15-20
3/8"	31-35
1/2"	35-45
5/8"	75-80





## 9. Trouble shooting

### 9.1 Outdoor control diagram

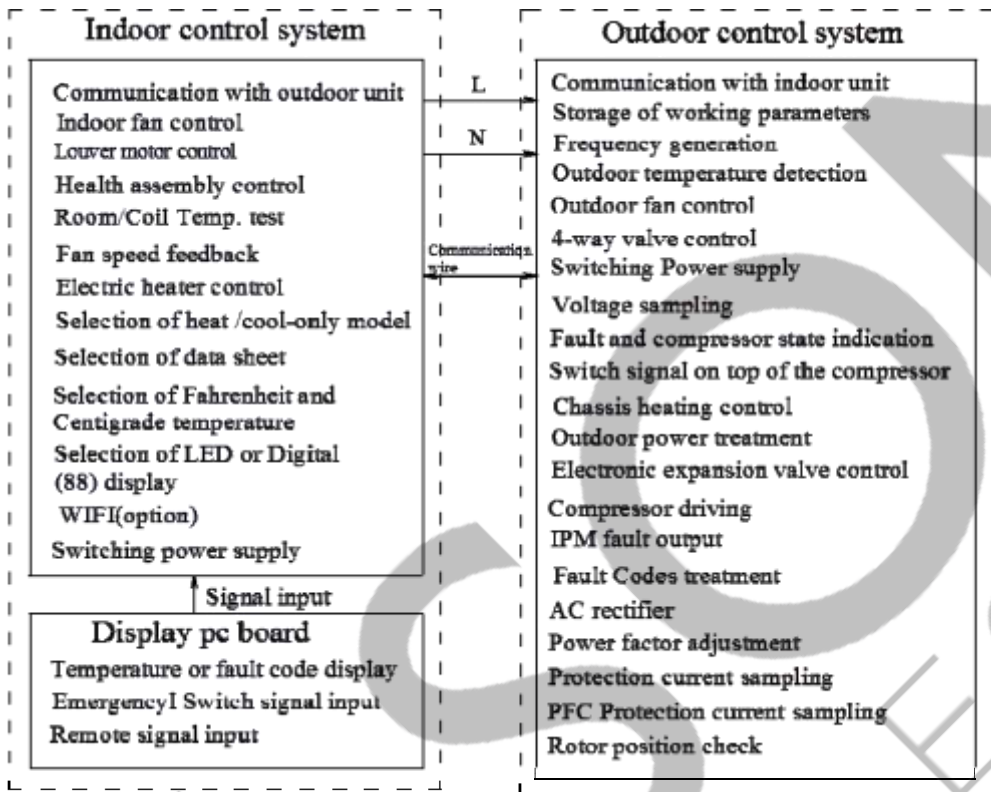

### 9.2 The structure of ODU PCB

#### ONE TO 2 TYPE

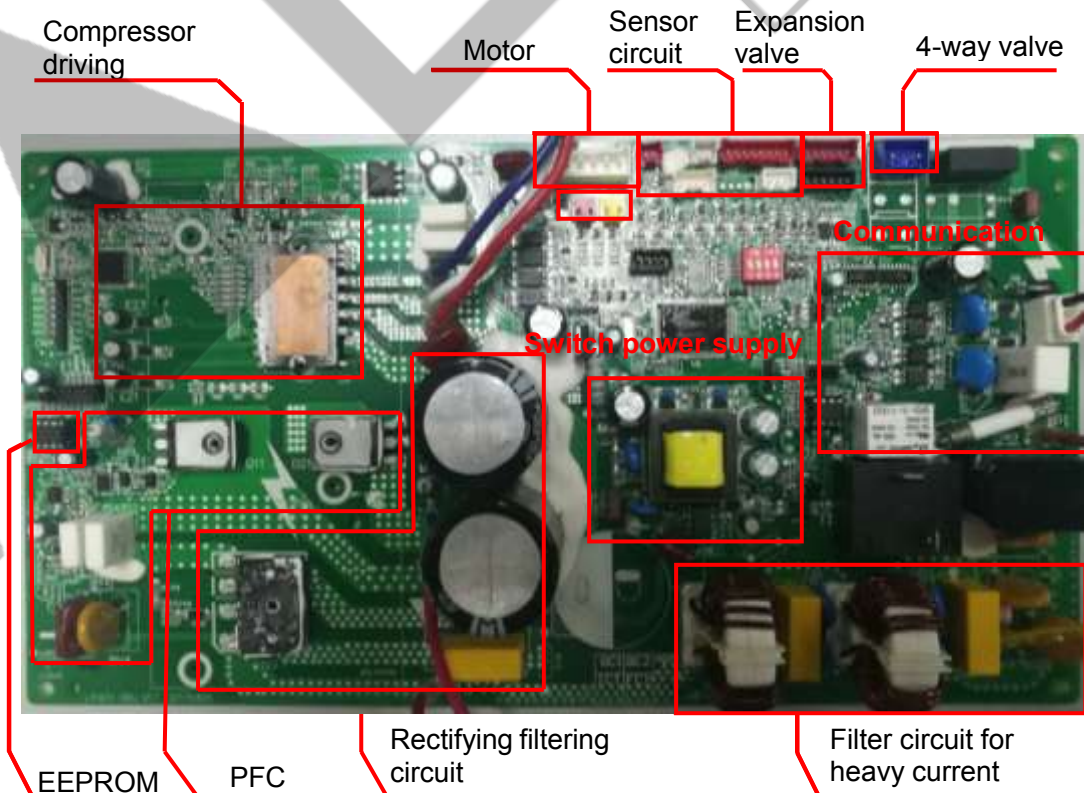

**ONE TO 3/4 TYPE:**

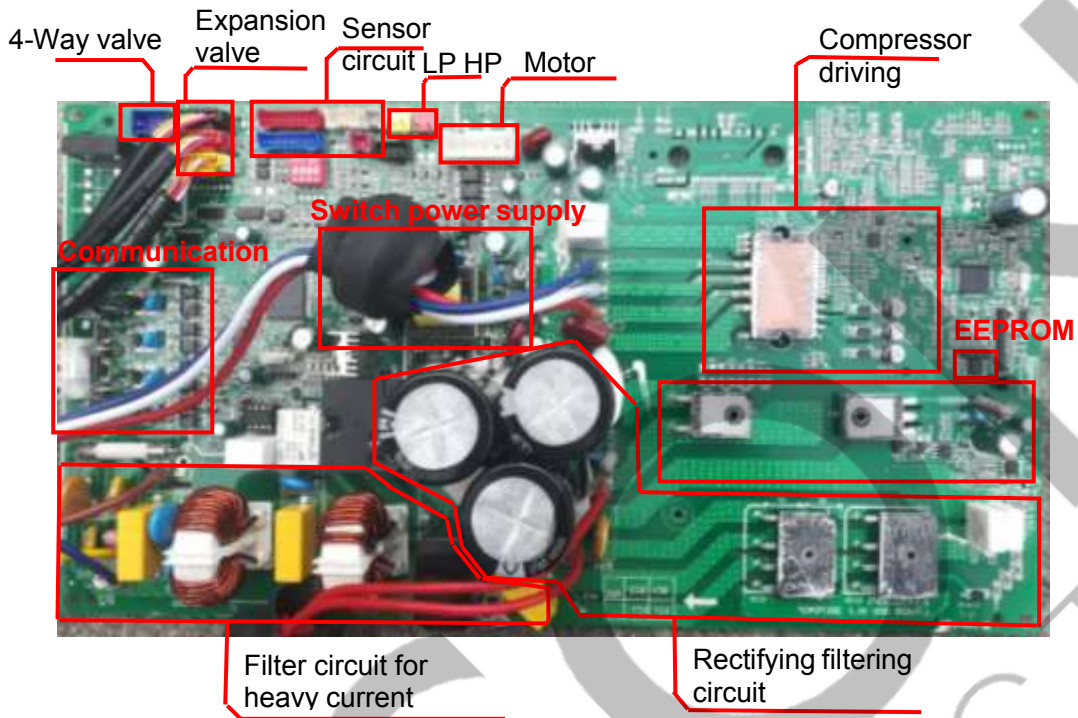

**9.3 Examples of repairing**

**9.3.1 Display E1 or E2**

**Reasons:**

- 1) The sensor connection terminal loose or not plugged in.

Wall type

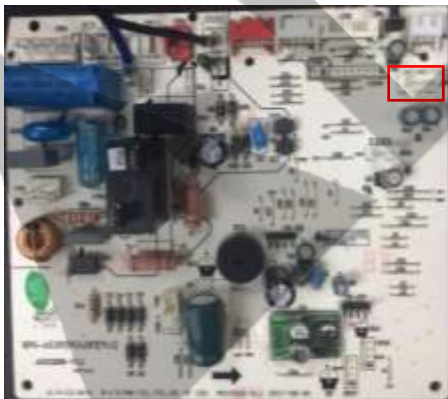

Cassette type/Duct type



**Solution:** Check the connector of sensor and slot (CN6, CN6-1, CN6-2), if loose or not plugged in, please connect again.

- 2) Room temperature sensor (IRT) and Indoor pipe (coil) temperature sensor (IPT) damage (short or broken).

**Solution:** check the resistance of the sensor wall type  $R(25^{\circ}\text{C}) = 5\text{ k}\Omega$ , cassette and duct type  $R(25^{\circ}\text{C}) = 5\text{ k}\Omega$ , if short or broken please replace it.



- 3) The PCB fail.  
**Solution:** Replace the indoor main PCB.

### 9.3.2 Display E6

#### Reasons:

- 1) The indoor motor connection terminal loose or not plugged in.

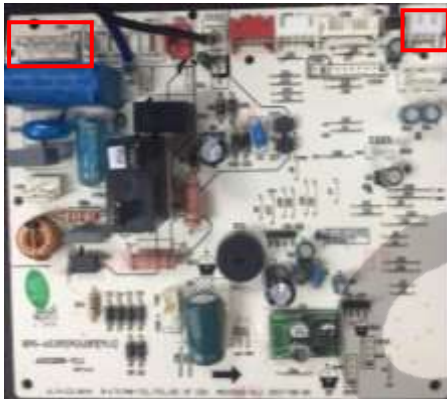

**Solution:** Check the connector of indoor motor and slot (CN3) and (CN4), if loose or not plugged in, please connect again.

- 2) The indoor motor damage.

**Solution:** Check and replace the motor.



- 3) The indoor main PCB damage.

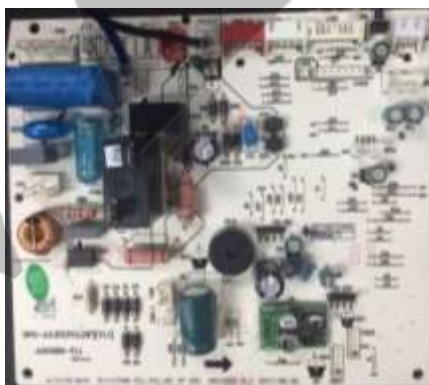

**Solution:** Replace the indoor main PCB.

### 9.3.3 Display E3, E7

**Reasons:**

- 1) Outdoor pipe temp sensor, outdoor temp sensor & exhaust temp sensor connection terminal loose or not plugged in.

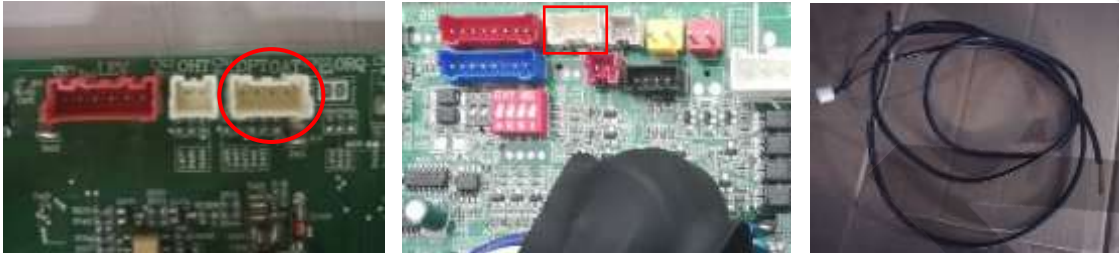

**Solution:** Check the connector of sensor and slot, if loose or not plugged in, please connect again.

- 2) Outdoor pipe temp sensor, outdoor temp sensor & exhaust temp sensor damage (short or broken).

**Solution:** Check and replace the sensor.

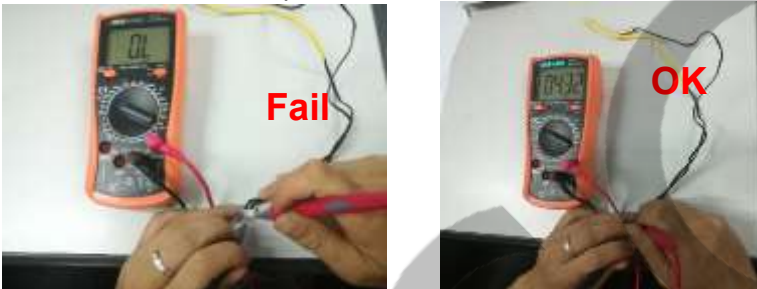

- 3) Outdoor PCB damage.

**Solution:** Check and replace the outdoor PCB.

### 9.3.4 Display E8

**Reasons:**

- 1) Outdoor discharge pipe temp sensor connection terminal loose or not plugged in.

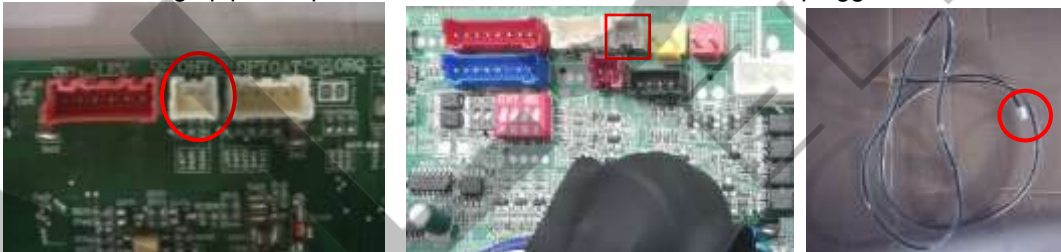

**Solution:** Check the connector of sensor and slot, if loose or not plugged in, please connect again.

- 2) Outdoor pipe temp sensor damage.

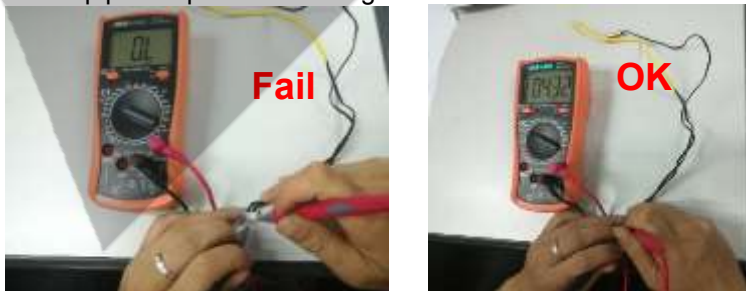

**Solution:** Check and replace the sensor.

- 3) Outdoor PCB damage.

**Solution:** Check and replace the outdoor PCB.

### 9.3.5 Display E0,E5

**Reason:** Indoor / outdoor communication damage.

**Solution:**

- 1) Check if the indoor and outdoor connections are correct. The terminal L and N which connect to indoor unit shall correspond to each other on indoor and outdoor units. Measure the voltage on outdoor

terminal L and N (before display of E0 fault). If the voltage is "0", please replace indoor main PCB.



2) If the 1 & N which connect to indoor unit voltage is normal, measure the voltage between the outdoor terminal 1A, 1B, 1C, 1D and N. If the voltage change occurs between 0~24V (change pulse voltage), please replace indoor main PCB.

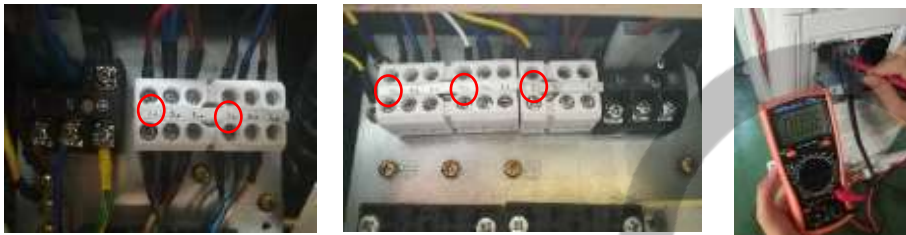

3) If the 1A, 1B, 1C, 1D & N which connect to indoor unit voltage is normal, measure the voltage between the outdoor terminal 1 and N. If the voltage change occurs between 0~12V( change pulse voltage), but there is no 24V, please replace the outdoor PCB.



4) If the 1, 1A, 1B, 1C, 1D & N voltage is normal, measure the voltage between the outdoor terminal 1 and N. If the voltage has no change, firstly replace the indoor main PCB. If the fault remains unsolved, replace the outdoor PCB.

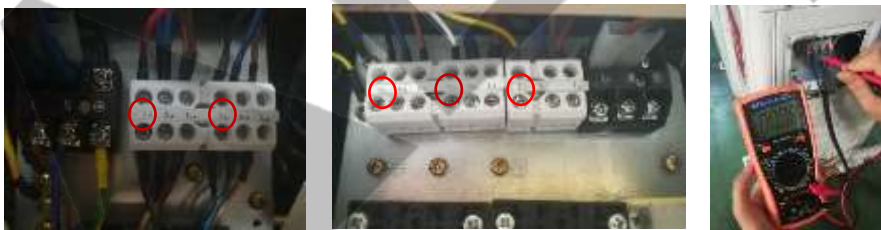

5) Communication fault if resistance or optical coupler broken, replace outdoor PCB.

Is there any burnt on PCB? If no, test the rectifier, FRD, IGBT etc. any component broken, replace PCB.

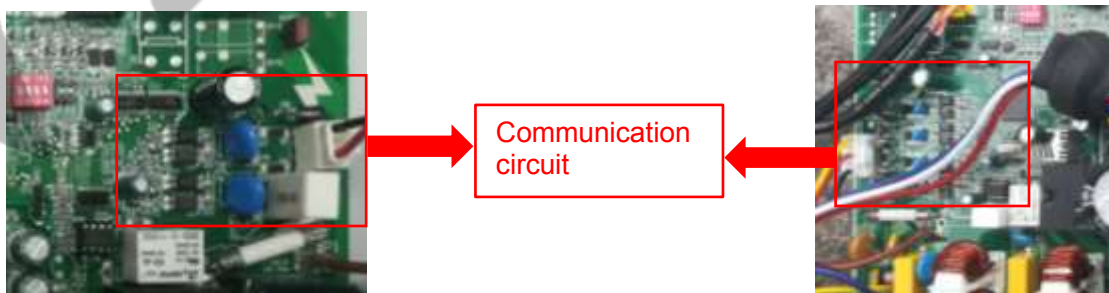

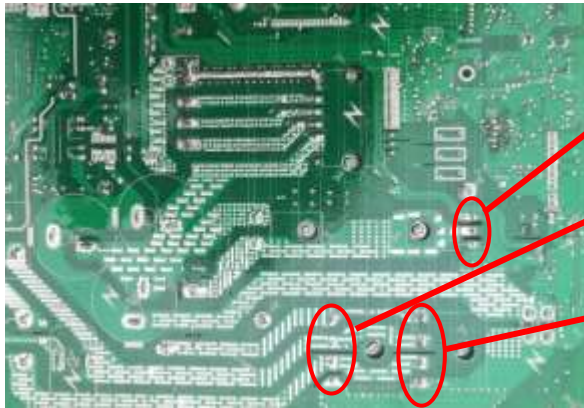

- Any of 2 pins should be no short circuit
- Any of 2 pins should be no short circuit
- Any of 2 pins should be no short circuit

6) Test the DC voltage between DC+ and DC-. If the voltage is less than 50V approximately, please replace outdoor PCB.

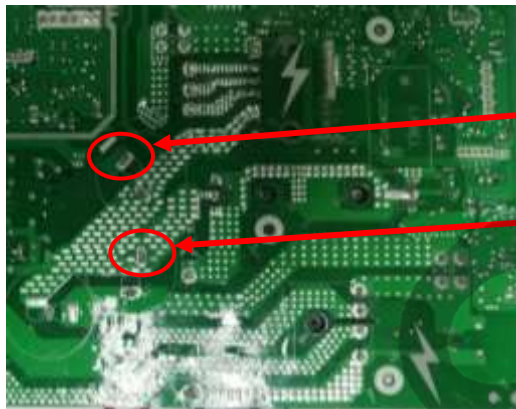

**DC+**  
**DC-**

**9.3.6 Display EA**

**Reason: Current sensor fault.**

**Solution:**

- 1) Check for refrigerant leakage, to find the leakage point and recharge the refrigerant.
- 2) Current sampling circuit broken on the outdoor PCB and replace outdoor PCB.

**9.3.7 Display E9 (first display P0 or P9) Reason:**

**Outdoor PCB drive circuit damage. Solution:**

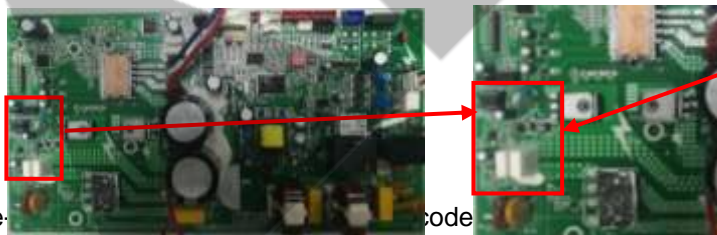

Current sampling circuit

Re- code display P0.

- 1) If this code is displayed when the compressor is started for several seconds or even not started, check the compressor connection for correctness, if no insert wrong, replace outdoor PCB.

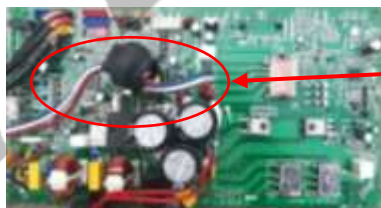

Compressor connection

- 2) Check if the outdoor module is tightly installed onto the radiating fins and if the silicone is applied evenly, fix the screws again if loose.

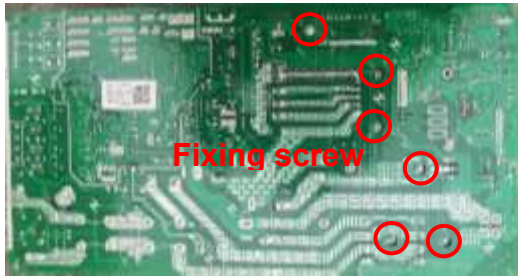

Heat radiation problem easily happened while the screw is not fixed tightly.

- 3) Check the system pressure, recharge refrigerant if the pressure is low, and discharge some refrigerant if the pressure is too high.
- 4) Check the outdoor ventilation and if there is any obstruction that affects the normal radiating of the air conditioner, and installation again.
- 5) If the above inspections are normal, but the fault remains unsolved, please replace the outdoor PCB. Re-energize and check the protection code on display. Firstly display P9.
  - a) Check the U,V, W connection, if is correctness or loose please connect again.

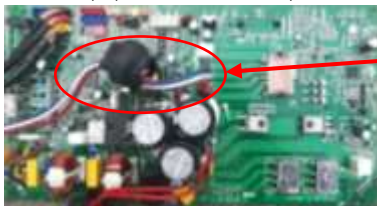

U, V, W connection

- b) If this code is displayed when the compressor is started for several seconds or even not started, check the compressor connection for correctness, if no insert wrong, replace outdoor PCB.

### 9.3.8 Display EU.

Reason: Voltage sensor damage.

Solution: Please replace outdoor PCB.

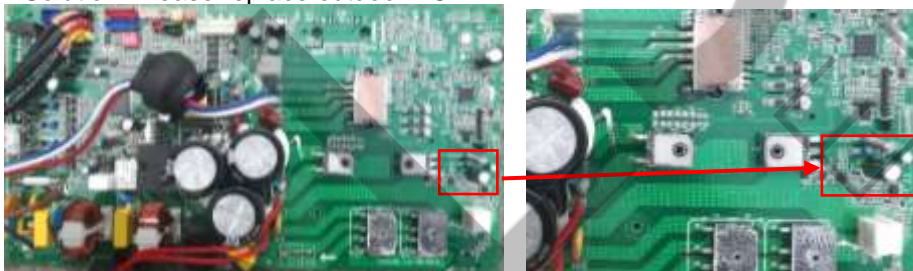

Voltage sensor

### 9.3.9 Display EE

Reason: EEPROM fault.

Solution: Shut down power supply and reenergize it, if the fault remains there, check the EEPROM installation, if no problem, please replace outdoor PCB.

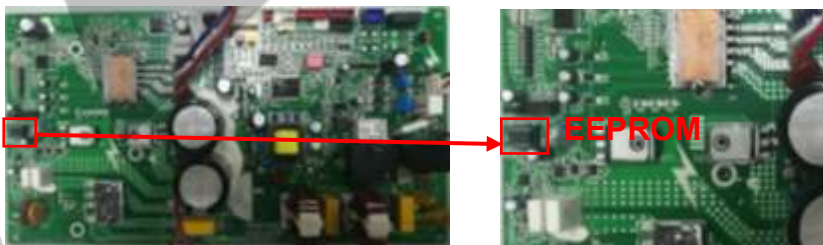

EEPROM

### 9.3.10 Display E4

Reason: IPM high current protection or Compressor phase loss or the power off instantaneously.

Solution: 1. Check the compressor phase whether loss.

2. If the compressor phase not loss, please cut the power off and give again. If the unit can run at normal, maybe the IPM high current protection or the power off instantaneously.

3. If the unit can't operate, please replace outdoor PCB

#### 9.3.11 Display EC

**Reason:** The signal communication fault between power module and IPM module.

**Solution:** Please replace the outdoor PCB.

#### 9.3.12 Display EP

**Reason:** The compressor top temperature high or the sensor fault.

**Solution:** Check and replace the sensor or add some gas.

#### 9.3.13 Display PA

**Reason:** Two or three machine modes collide.

**Solution:** Check whether one machine run in cooling another machine run in heating or other model.

#### 9.3.14 Display D3.

**Reason:** Water full (This only apply to cassette or duct type).

**Solution:** Check and let water drain.

#### 9.3.15 Display CL

**Cause:** Air filter duty, the unit operation Cumulative time 500 hours, the controller will confirmation the filter dirty and display CL.

**Solution:** Clean the air filter then cut off the power and supply again.



### 9.4 MALFUNCTION (PARTS) CHECK METHOD

#### 9.4.1 Procedure for determining defective outdoor unit IPM/compressor

The following flow chart shows a procedure for locating the cause of a malfunction when the compressor does not start up and a DC overcurrent indication error occurs.

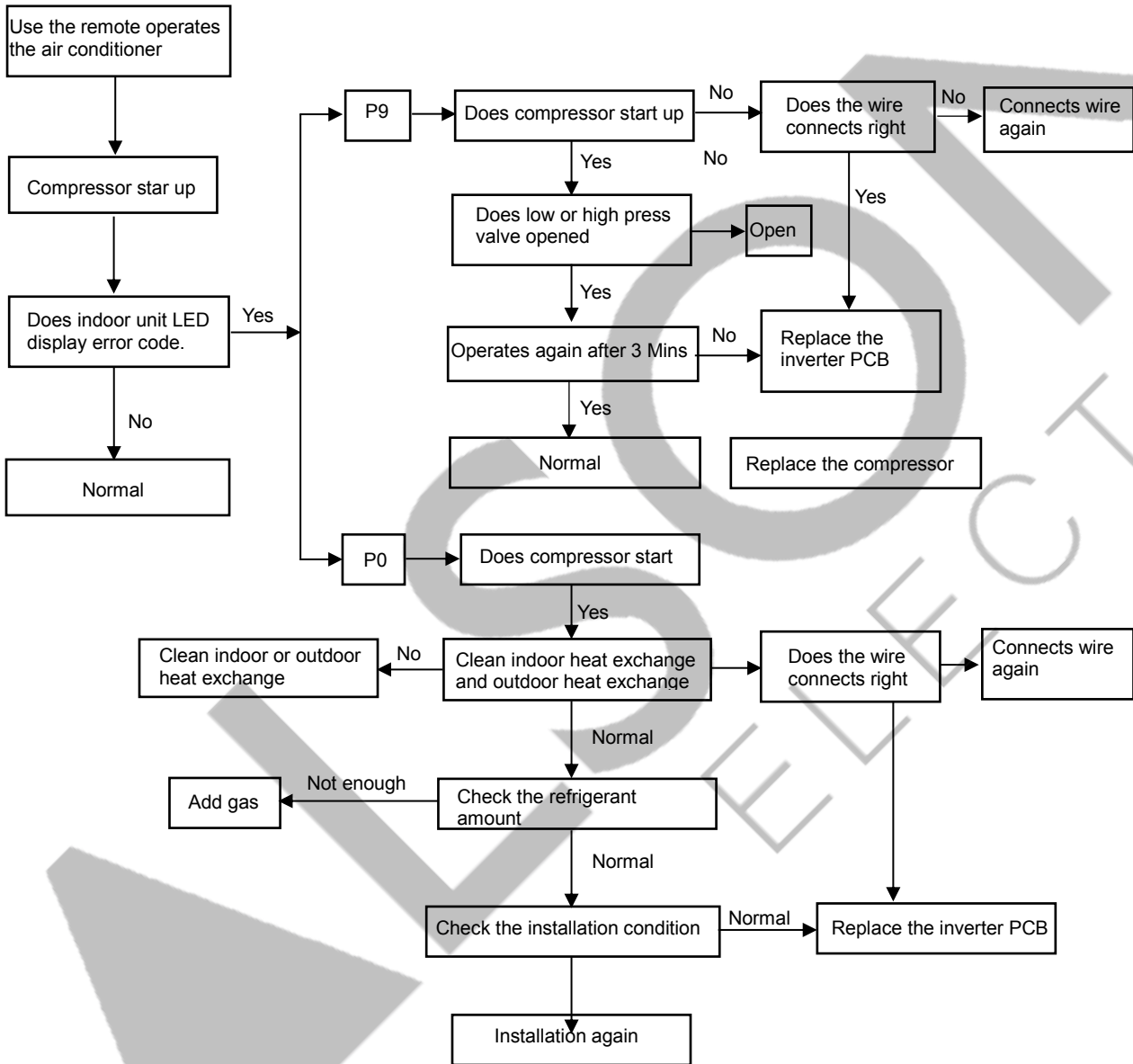

9.4.2 DC Over Current Error

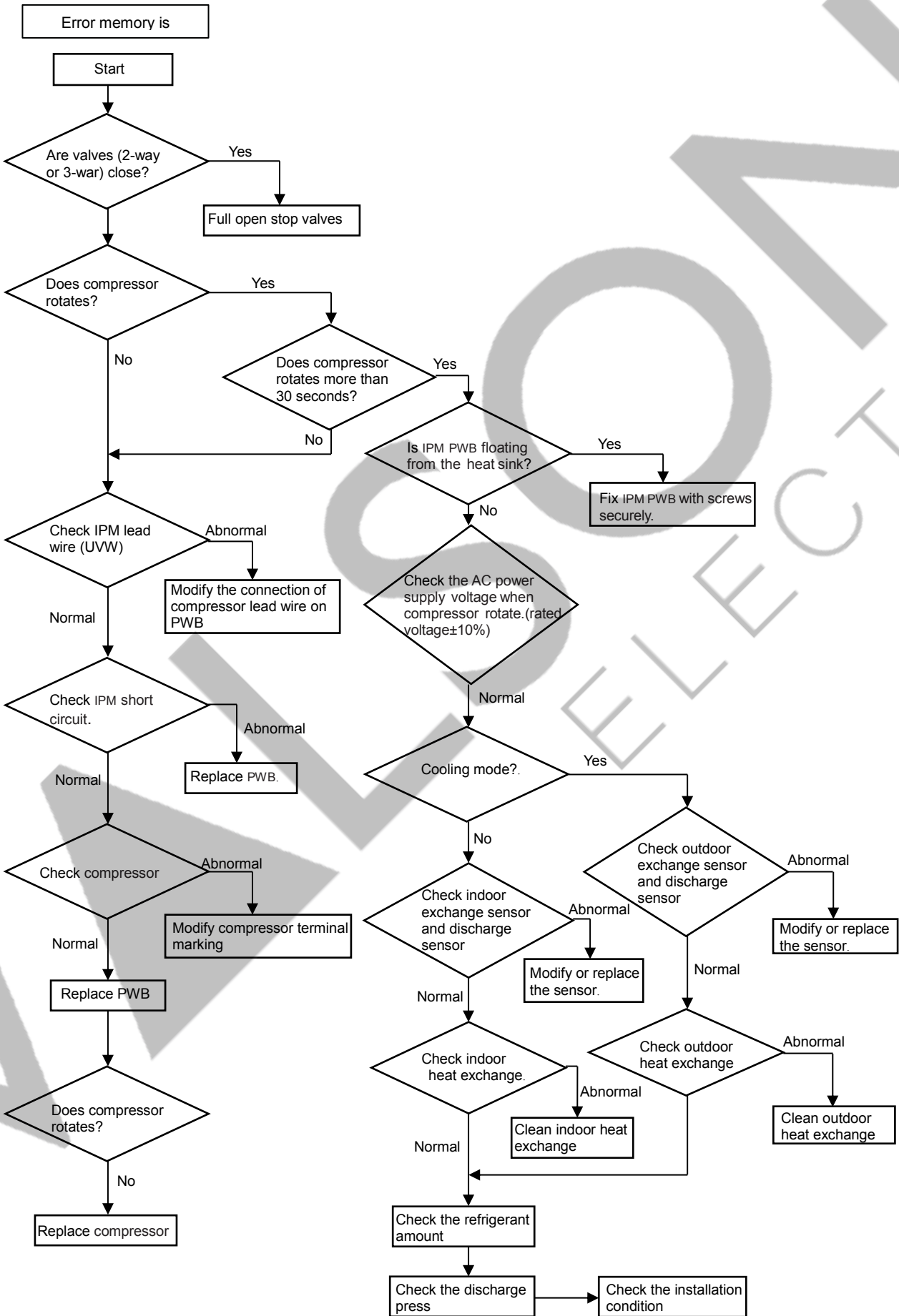

### 9.4.3 E0,E5 Error

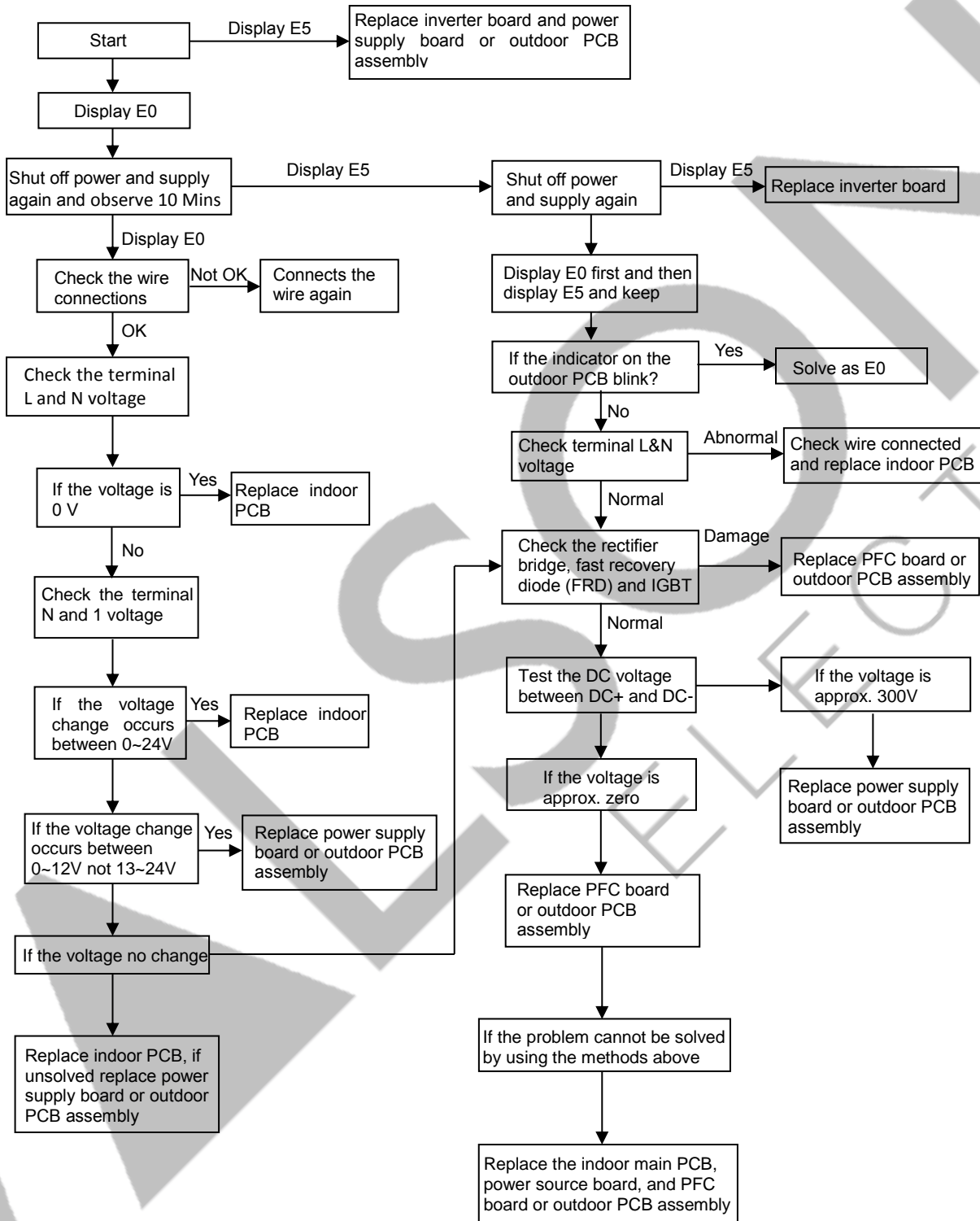

## 9.5 THERMISTOR TEMPERATURE CHARACTERISTICS

### 1. Indoor unit and outdoor exchange temperature and outside air temperature sensor temperature characteristics

TEMP. (°C)	Resistance (k Ohm)	Voltage of resistance	TEMP. (°C)	Resistance (k Ohm)	Voltage of resistance	TEMP. (°C)	Resistance (k Ohm)	Voltage of resistance
-30	63.513	4.628	15	7.447	2.968	60	1.464	1.115
-29	60.135	4.609	16	7.148	2.918	61	1.418	1.088
-28	56.956	4.589	17	6.863	2.868	62	1.374	1.061
-27	53.963	4.568	18	6.591	2.819	63	1.331	1.035
-26	51.144	4.547	19	6.332	2.769	64	1.290	1.009
-25	48.488	4.524	20	6.084	2.720	65	1.250	0.984
-24	45.985	4.501	21	5.847	2.671	66	1.212	0.960
-23	43.627	4.477	22	5.621	2.621	67	1.175	0.936
-22	41.403	4.452	23	5.404	2.572	68	1.139	0.913
-21	39.305	4.426	24	5.198	2.524	69	1.105	0.890
-20	37.326	4.399	25	5.000	2.475	70	1.072	0.868
-19	35.458	4.371	26	4.811	2.427	71	1.040	0.847
-18	33.695	4.343	27	4.630	2.379	72	1.009	0.825
-17	32.030	4.313	28	4.457	2.332	73	0.979	0.805
-16	30.458	4.283	29	4.292	2.285	74	0.950	0.785
-15	28.972	4.252	30	4.133	2.238	75	0.922	0.765
-14	27.567	4.219	31	3.981	2.192	76	0.895	0.746
-13	26.239	4.186	32	3.836	2.146	77	0.869	0.728
-12	24.984	4.152	33	3.697	2.101	78	0.843	0.710
-11	23.795	4.117	34	3.563	2.057	79	0.819	0.692
-10	22.671	4.082	35	3.435	2.012	80	0.795	0.675
-9	21.606	4.045	36	3.313	1.969	81	0.773	0.658
-8	20.598	4.008	37	3.195	1.926	82	0.751	0.641
-7	19.644	3.969	38	3.082	1.883	83	0.729	0.625
-6	18.732	3.930	39	2.974	1.842	84	0.709	0.610
-5	17.881	3.890	40	2.870	1.800	85	0.689	0.595
-4	17.068	3.850	41	2.770	1.760	86	0.669	0.580
-3	16.297	3.808	42	2.674	1.720	87	0.651	0.566
-2	15.565	3.766	43	2.583	1.681	88	0.633	0.552
-1	14.871	3.723	44	2.494	1.642	89	0.615	0.538
0	14.212	3.680	45	2.410	1.604	90	0.598	0.525
1	13.586	3.635	46	2.328	1.567	91	0.582	0.512
2	12.991	3.590	47	2.250	1.530	92	0.566	0.499
3	12.426	3.545	48	2.174	1.495	93	0.550	0.487
4	11.889	3.499	49	2.102	1.459	94	0.535	0.475
5	11.378	3.452	50	2.032	1.425	95	0.521	0.463
6	10.893	3.406	51	1.965	1.391	96	0.507	0.452
7	10.431	3.358	52	1.901	1.357	97	0.493	0.441
8	9.991	3.310	53	1.839	1.325	98	0.480	0.430
9	9.573	3.262	54	1.779	1.293	99	0.467	0.419
10	9.174	3.214	55	1.721	1.262	100	0.455	0.409
11	8.795	3.165	56	1.666	1.231			
12	8.433	3.116	57	1.613	1.201			
13	8.089	3.067	58	1.561	1.172			
14	7.760	3.017	59	1.512	1.143			

Resistance at 25°C : wall split type 5 kΩ, cassette and duct 10kΩ.

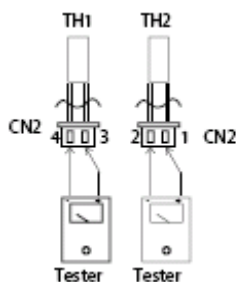

TH1: indoor room temperature sensor and outside air temperature sensor

TH2: indoor exchange temperature sensor and outside exchange temperature sensor

Before measuring resistance, disconnect connectors as shown above.

**2. Outdoor unit sensor temperature characteristics**

TEMP (°C)	R min (k Ohm)	R(t) (k Ohm)	R max (k Ohm)	TEMP. (°C)	R min (k Ohm)	R(t) (k Ohm)	R max (k Ohm)	TEMP. (°C)	R min (k Ohm)	R(t) (k Ohm)	R max (k Ohm)
-30	283.3	322.9	367.7	24	19.36	20.89	22.52	78	2.563	2.654	2.745
-29	267.4	304.4	346.3	25	18.55	20	21.54	79	2.481	2.567	2.654
-28	252.5	287.1	307.4	26	17.77	19.14	20.6	80	2.402	2.484	2.567
-27	238.5	270.9	307.4	27	17.03	18.32	19.7	81	2.327	2.404	2.483
-26	225.4	255.7	289.8	28	16.32	17.55	18.85	82	2.254	2.327	2.401
-25	213.1	241.4	273.3	29	15.65	16.81	18.04	83	2.183	2.253	2.323
-24	201.5	228	257.9	30	15	16.1	17.27	84	2.115	2.182	2.248
-23	190.6	215.5	243.4	31	14.39	15.43	16.54	85	2.05	2.113	2.176
-22	180.3	203.6	229.8	32	13.81	14.79	15.34	86	1.985	2.047	2.109
-21	170.7	192.5	217	33	13.25	14.18	15.17	87	1.922	1.983	2.045
-20	161.6	182.1	205	34	12.72	13.6	14.54	88	1.861	1.922	1.983
-19	153.1	172.3	193.7	35	12.21	13.05	13.93	89	1.802	1.862	1.923
-18	145	163.1	183.2	36	11.72	12.52	13.36	90	1.746	1.805	1.865
-17	137.5	154.4	173.2	37	11.26	12.01	12.81	91	1.692	1.75	1.809
-16	130.3	146.2	163.9	38	10.82	11.53	12.29	92	1.639	1.697	1.755
-15	123.6	138.5	155.1	39	10.29	11.07	11.78	93	1.589	1.646	1.703
-14	117.3	131.3	146.8	40	9.986	10.63	11.31	94	1.54	1.596	1.653
-13	111.3	124.4	139	41	9.6	10.21	10.85	95	1.493	1.549	1.604
-12	105.6	118	131.7	42	9.231	9.813	10.42	96	1.448	1.502	1.558
-11	100.3	111.9	124.7	43	8.878	9.43	10	97	1.404	1.458	1.512
-10	95.24	106.2	118.2	44	8.54	9.064	9.612	98	1.362	1.415	1.469
-9	90.49	100.8	112.1	45	8.217	8.714	9.233	99	1.321	1.373	1.426
-8	85.99	95.68	106.3	46	7.908	8.38	8.872	100	1.284	1.335	1.387
-7	81.75	90.86	100.8	47	7.612	8.06	8.526	101	1.245	1.296	1.348
-6	77.74	86.31	95.74	48	7.328	7.754	8.196	102	1.209	1.258	1.309
-5	73.94	82.01	90.88	49	7.057	7.461	7.88	103	1.173	1.222	1.272
-4	70.35	77.95	86.29	50	6.797	7.18	7.578	104	1.139	1.187	1.236
-3	66.96	74.11	81.96	51	6.548	6.912	7.289	105	1.105	1.153	1.202

-2	63.74	70.48	77.87	52	6.309	6.655	7.013	106	1.073	1.12	1.168
-1	60.69	67.05	74	53	6.08	6.409	6.748	107	1.042	1.089	1.136
0	57.81	63.8	70.34	54	5.861	6.173	6.495	108	1.013	1.058	1.104
1	55.08	60.72	66.88	55	5.651	5.947	6.253	109	0.9833	1.028	1.074
2	52.49	57.81	63.61	56	5.449	5.73	6.02	110	0.9553	0.9997	1.045
3	50.03	55.05	60.52	57	5.255	5.522	5.798	111	0.9283	0.9719	1.016
4	47.71	52.44	57.59	58	5.07	5.323	5.585	112	0.9021	0.9451	0.9892
5	45.5	49.97	54.82	59	4.891	5.132	5.381	113	0.8765	0.9191	0.9626
6	43.41	47.62	52.2	60	4.72	4.949	5.101	114	0.8524	0.894	0.9367
7	41.42	45.4	49.71	61	4.556	4.774	4.997	115	0.8087	0.8595	0.9117
8	39.53	43.2	42.33	62	4.398	4.605	4.817	116	0.8059	0.8461	0.8875
9	37.74	41.29	45.12	63	4.247	4.448	4.644	117	0.7837	0.8233	0.8641
10	36.04	39.39	43.01	64	4.101	4.288	4.479	118	0.7623	0.8012	0.8413
11	34.42	37.59	41	65	3.961	4.139	4.32	119	0.7415	0.7798	0.8193
12	32.89	35.87	39.1	66	3.827	3.995	4.167	120			
13	31.43	34.25	37.29	67	3.698	3.858	4.021	121	0.702	0.7386	0.7773
14	30.04	32.71	35.58	68				122	0.6631	0.7195	0.7572
15	29.72	31.24	33.95	69				123	0.6649	0.7007	0.7378
16				70	3.339	3.476	3.616	124	0.6472	0.6824	0.7189
17				71	3.229	3.359	3.491	125	0.6301	0.6647	0.7006
18	25.13	27.26	29.55	72	3.122	3.246	3.372	126	0.6135	0.6476	0.6829
19	24.05	26.07	28.23	73	3.02	3.138	3.257	127	0.5974	0.6309	0.6657
20	23.02	24.93	26.97	74	2.921	3.033	3.146	128	0.5818	0.6148	0.649
21	22.04	23.84	25.77	75	2.827	2.933	3.04	129	0.5667	0.5991	0.6328
22	21.1	22.81	24.63	76	2.735	2.836	2.938	130	0.5521	0.5839	0.6171
23	20.21	21.83	23.55	77	2.647	2.743	2.84				

**R—Resistance**

**Resistance at 25°C : 20 kΩ**

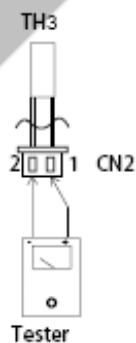

**TH3: Outdoor unit discharge pipe sensor**

**Before measuring resistance, disconnect connectors as shown above.**